



SOLUTIONS GUIDE

OFFERING FOR LOW VOLTAGE ELECTRICAL PANELS



STANDARDS FOR ELECTRICAL PANELS

In IEC standard 61439 a builder of distribution and control boards – or panel builder – is recognized as a key player in the field of LV switchgear and controlgear.

The new standard, IEC 61439, superseded the old standard IEC 60439 in November 2014, and perfectly defines the lines of work and responsibilities of original manufacturers, assembly manufacturers and electrical contractors (see diagram).



Original switchgear manufacturers are legally liable for the switchgear they manufacture and ship throughout design and inspection. IEC standard 60947 and its headings IEC 60947-1, -2, -3, -4 set the rules.

Assembly manufacturers (panel builders) are legally liable for the assemblies they build throughout design and inspection, especially when they modify a subassembly shipped by an original manufacturer or use an untested component. IEC standard 61439 sets the rules. Panel builders, who may be assembly manufacturers, are legally liable for the installation. IEC standard 60364 (NF C 1500 in France) sets the rules on design and construction of electrical installations.

Mersen, formerly Ferraz Shawmut, is recognized in the world of power electronics as an expert in low voltage protection, both for current and voltage. Mersen is a global expert in protect against current surges, short-circuit currents and overloads, and also transient voltage surges due to lightning or switching. That expertise translates into a product portfolio that is exceptional for both the range and depth of the solutions it offers. Design and production of all those products are completely controlled within the company. Above and beyond the intrinsic quality of our products, the Mersen brand can rely on world-class technical support made available to customer to define and choose the most suitable solution for the need.

To meet the needs of manufacturers making electrical panels for control and instrumentation, Mersen proposes a wide range of fuse protection solutions covering all the leading technologies on the international market to meet the requirements of all the major international standards. Those fuses can be installed in panels using a range of devices, most of them mountable on DIN rails. Mersen's fusegear is renowned for its compact footprint and exceptional thermal performances thanks to the use of appropriate plastic materials - performances that are only enhanced by the low power dissipation of our fuses.

MERSEN IS ALSO A GLOBAL EXPERT IN SURGE PROTECTION

Mersen's position as a specialist in the safety & reliability of electrical power, especially in protection and control, and our commitment to compact, thermally efficient switchgear make us a valued partner for assembly manufacturers.



COMPLETE TECHNICAL INFORMATION AT EP.MERSEN.COM

Products are available in online catalog
(Products top bar) via a 4-level architecture
(family, group, type and Model Series Line)

Downloadable data sheet in different
languages
with very comprehensive
data tables

VIEW AT THE FOURTH LEVEL OF
ARCHITECTURE

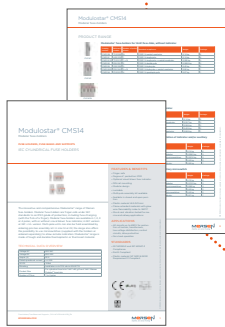

More detailed
information available
when toggling

Combined products









The screenshot shows the Mersen website interface. At the top, there's a navigation bar with 'PRODUCTS' highlighted. Below it, a banner for 'NEW SURGE-TRAP® UL/CSA TYPE 1 SPD LINE' is visible. The main content area is titled 'FUSE HOLDERS, FUSE BASES AND SUPPORTS' and includes a breadcrumb trail: 'United Kingdom > Products > Fuses, Fusegear, and Fuse Systems > Fuse Holders, Fuse Bases and Supports > IEC Cylindrical Fuse Holders > ModuStar® CMS10'. There are several search and navigation tools on the right side, including 'FIND WHAT YOU NEED FAST...' with options for Catalog search, Cross Reference Search, CAD File, and Site Search. Below these are sections for 'WHERE TO BUY' and 'LEAD PROTECTION VIDEO'. The main content area also features a 'FEATURES' section, 'PRODUCT DETAILS', 'CATALOG-REFERENCE', 'CAD & OUTLINE DRAWINGS', and 'RESOURCES' with a list of certificates and data sheets. At the bottom, there's a 'RELATED PRODUCTS' section showing 'Ferrule fuse-links'.

Compliance documents
Declarations
Approval certificates



ep.mersen.com

MERSEN OFFERING FOR LOW VOLTAGE ELECTRICAL PANELS

	OFFERING			FUNCTION	
	PRODUCTS	RANGES	STANDARDS	ISOLATING	OVERCURRENT PROTECTION
	Fuses and holders	Cylindrical fuses, Modulostar®	IEC, UL	●	●
	Fuses and bases	NH Fuses, DO	DIN	●	●
	Fuse Switch Disconnectors	Multivert®, Multibloc®, Multifix® 60	DIN	●	●
	Switch Fuse Disconnectors	Switch Fuse Disconnectors, Linocur®	IEC, DIN, UL	●	●
	Fuses and holders	BS88	BS	●	●
	Surge Protective Devices	Surge-Trap®	IEC, UL		
	Switch Disconnectors	Switch Disconnectors	IEC, UL	●	
	Power Distribution Blocks	FSPDB	IEC, UL	●	

ENERGY
EFFICIENT



SMALL
IS THE
BEST

HelioProtection®

			MOUNTING			COMMUNICATION	PAGES
SHORT-CIRCUIT PROTECTION	OVERVOLTAGE PROTECTION	BREAKING	DIN RAIL	BUSBAR	SCREWING	MONITORING	
●		●	●			●	6-15
●			●	●	●		16-41
●		●	●	●	●	●	19-31
●		●	●	●	●	●	11-38
●							42-51
	●		●		●	●	52-62
		●	●		●	●	64-67
			●				63

Regarding electrical panels for PV systems refer to our HelioProtection® Program brochure. It is available on ep.mersen.com

For electrical panels regarding drives please consult our website ep.mersen.com for IEC cylindrical, square-body and NH square-body high-speed fuses in Semiconductor Protection Fuses section. Related bases and holders are in Fuse Holders, Fuse Bases and Supports section .

CYLINDRICAL FUSES & FUSEGEAR OFFERING

Cylindrical fuses

			FUSES					
			GG			AM		
SIZE	VOLTAGE	BREAKING CAPACITY	W/O INDICATION	WITH INDICATION	WITH STRIKER	W/O INDICATION	WITH INDICATION	WITH STRIKER
8x31 	400VAC	20kA	0,5 - 25A	2 - 25A	–	1 - 12A	–	–
10x38 	500VAC	120kA	0,5 - 25A	2 - 25A	–	0,16 - 20A	1 - 20A	–
	400VAC	100 - 120kA	32A	32A	2 - 20A	25 - 32A	25A	2 - 20A
	250VAC	100kA	–	–	25 - 32A	–	–	25 - 32A
	690VAC	120kA	1-16A	–	–	1 - 12A	–	–
14x51 	690VAC	120kA	1 - 50A	–	–	0,25 - 40A	–	1 - 16A
	500VAC	120kA	–	–	1 - 50A	45 - 50A	–	20 - 50A
22x58 	690VAC	120kA	2 - 80A	–	2 - 80A	1 - 80A	–	1 - 80A
	500VAC	120kA	100 - 125A	–	100 - 125A	100 - 125A	–	100 - 125A

Fusegear

FUSE HOLDERS FUSE DISCONNECTORS		SWITCH FUSE DISCONNECTORS	PAGES
COMPACT	MODULAR		
CCR8 	CMS8 	—	8
CCR10 / USFM 	CMS/US10 	M25F12, M25F30S 	9-11
CC14 	CMS/US14 	M50F03, M50F30S 	12-13
CC22 	CMS/US22 	M125F03, M125F30S 	14-15

LOW VOLTAGE CYLINDRICAL FUSES

Size 8x31



gG

400 VAC

Breaking capacity: 20 kA

W/o indication

CAT. NUMBER	REF. NUMBER	VOLTAGE VAC (-)	CURRENT (A)	PKG
FR8GG40V0.5	P218191	400VAC	0.5A	10
FR8GG40V1	C218709	400VAC	1A	10
FR8GG40V10	A214613	400VAC	10A	10
FR8GG40V16	P216650	400VAC	16A	10
FR8GG40V2	Q219227	400VAC	2A	10
FR8GG40V20	F217677	400VAC	20A	10
FR8GG40V25	D218710	400VAC	25A	10
FR8GG40V6	A211025	400VAC	6A	10
FR8GG40V8	B213096	400VAC	8A	10

With indication

CAT. NUMBER	REF. NUMBER	VOLTAGE VAC (-)	CURRENT (A)	PKG
FR8GG40V12I	C213097	400VAC	12A	10
FR8GG40V16I	Y214105	400VAC	16A	10
FR8GG40V20I	J215127	400VAC	20A	10
FR8GG40V25I	S216147	400VAC	25A	10
FR8GG40V2I	B222204	400VAC	2A	10
FR8GG40V4I	X222959	400VAC	4A	10
FR8GG40V6I	V201291	400VAC	6A	10
FR8GG40V8I	B211026	400VAC	8A	10



aM

400 VAC

Breaking capacity: 20 kA

W/o indication

CAT. NUMBER	REF. NUMBER	VOLTAGE VAC (-)	CURRENT (A)	PKG
FR8AM40V1	C217168	400VAC	1A	10
FR8AM40V2	R218193	400VAC	2A	10
FR8AM40V4	S219229	400VAC	4A	10
FR8AM40V6	C222205	400VAC	6A	10
FR8AM40V8	F200749	400VAC	8A	10
FR8AM40V10	W201292	400VAC	10A	10
FR8AM40V12	V1007188	400VAC	12A	10

Neutral link

CAT. NUMBER	REF. NUMBER	PKG
FRN832	X211045	10

Fusegear 8x31

Compact - CCR8 fuse holder



NO. OF POLES	CAT. NUMBER	REF. NUMBER	NO. OF MOD.	PKG	LICENCE NF
1	CCR81	C200769	1	12	•
1+N	CCR81N	A218730	1	12	•
2	CCR82	V233721	2	6	
3	CCR83	W233722	3	4	

Modulostar® CMS8



CCD CONFIGURATIONS	CAT. NUMBER W/O INDICATION	REF. NUMBER W/O INDICATION	CAT. NUMBER WITH INDICATION	REF. NUMBER WITH INDICATION	PKG
1	CMS81	X305000	CMS81I	E305007	12
1+N	CMS81N	Y305001	CMS81NI	F305008	6
2	CMS82	Z305002	CMS82I	G305009	6
3	CMS83	A305003	CMS83I	H305010	4
3+N	CMS83N	B305004	CMS83NI	J305011	3
4	CMS84	C305005	CMS84I	K305012	3
N *	CMS810N	D305006	-	-	12

LOW VOLTAGE CYLINDRICAL FUSES

Size 10x38



gG

400/500 VAC
Breaking capacity: 120 kA

W/o indication

CAT. NUMBER	REF. NUMBER	VOLTAGE VAC (-)	CURRENT (A)	PKG
FR10GG50V0.5	C211027	500VAC	0.5A	10
FR10GG50V1	B212061	500VAC	1A	10
FR10GG50V2	D213098	500VAC	2A	10
FR10GG50V4	X213598	500VAC	4A	10
FR10GG50V6	K215128	500VAC	6A	10
FR10GG50V8	D217169	500VAC	8A	10
FR10GG50V16	G200750	500VAC	16A	10
FR10GG50V12	W219761	500VAC	12A	10
FR10GG50V10	S218194	500VAC	10A	10
FR10GG50V20	D211028	500VAC	20A	10
FR10GG50V25	E213099	500VAC	25A	10
FR10GG40V32	A214107	400VAC	32A	10

With indication

CAT. NUMBER	REF. NUMBER	VOLTAGE VAC (-)	CURRENT (A)	PKG
FR10GG50V2I	S216653	500VAC	2A	10
FR10GG50V4I	E217170	500VAC	4A	10
FR10GG50V6I	T218195	500VAC	6A	10
FR10GG50V8I	V219231	500VAC	8A	10
FR10GG50V10I	E222207	500VAC	10A	10
FR10GG50V12I	H200751	500VAC	12A	10
FR10GG50V16I	H201809	500VAC	16A	10
FR10GG50V20I	X211551	500VAC	20A	10
FR10GG50V25I	W212585	500VAC	25A	10
FR10GG40V32I	Z213600	400VAC	32A	10



aM

400/500 VAC
Breaking capacity: 120 kA

W/o indication

CAT. NUMBER	REF. NUMBER	VOLTAGE VAC (-)	CURRENT (A)	PKG
FR10AM50V0.16	E214617	500VAC	0.16A	10
FR10AM50V0.25	M215130	500VAC	0.25A	10
FR10AM50V0.5	W216150	500VAC	0.5A	10
FR10AM50V1	F217171	500VAC	1A	10
FR10AM50V2	H218714	500VAC	2A	10
FR10AM50V4	W219232	500VAC	4A	10
FR10AM50V6	F222208	500VAC	6A	10
FR10AM50V8	Z201295	500VAC	8A	10
FR10AM50V10	Y211552	500VAC	10A	10
FR10AM50V12	A213601	500VAC	12A	10
FR10AM50V16	F214618	500VAC	16A	10
FR10AM50V20	X216151	500VAC	20A	10
FR10AM40V25	G217172	400VAC	25A	10
FR10AM40V32	J218715	400VAC	32A	10

With indication

CAT. NUMBER	REF. NUMBER	VOLTAGE VAC (-)	CURRENT (A)	PKG
FR10AM50V1I	X219233	500VAC	1A	10
FR10AM50V2I	G222209	500VAC	2A	10
FR10AM50V4I	K200753	500VAC	4A	10
FR10AM50V6I	K201811	500VAC	6A	10
FR10AM50V8I	Z211553	500VAC	8A	10
FR10AM50V10I	H213102	500VAC	10A	10
FR10AM50V12I	D214110	500VAC	12A	10
FR10AM50V16I	P215132	500VAC	16A	10
FR10AM50V20I	V216655	500VAC	20A	10
FR10AM40V25I	L217682	400VAC	25A	10



LOW VOLTAGE CYLINDRICAL FUSES

Size 10x38



gG

250/400 VAC
Breaking capacity: 100 kA

With striker

CAT. NUMBER	REF. NUMBER	VOLTAGE VAC (-)	CURRENT (A)	PKG
FR10GG40V2P	G083703	400VAC	2A	10
FR10GG40V4P	D084758	400VAC	4A	10
FR10GG40V6P	Y084799	400VAC	6A	10
FR10GG40V8P	F083955	400VAC	8A	10
FR10GG40V10P	A084801	400VAC	10A	10
FR10GG40V12P	G083956	400VAC	12A	10
FR10GG40V20P	Z084800	400VAC	20A	10
FR10GG40V16P	X084798	400VAC	16A	10
FR10GG25V25P	H083957	250VAC	25A	10
FR10GG25V32P	E083954	250VAC	32A	10

690 VAC
Breaking capacity: 120 kA

W/o indication

CAT. NUMBER	REF. NUMBER	VOLTAGE VAC (-)	CURRENT (A)	PKG
FR10GG69V1	R302787	690VAC	1A	10
FR10GG69V2	S302788	690VAC	2A	10
FR10GG69V4	T302789	690VAC	4A	10
FR10GG69V6	V302790	690VAC	6A	10
FR10GG69V8	W302791	690VAC	8A	10
FR10GG69V10	X302792	690VAC	10A	10
FR10GG69V12	Y302793	690VAC	12A	10
FR10GG69V16	Z302794	690VAC	16A	10



aM

250/400 VAC
Breaking capacity: 100 kA

With striker

CAT. NUMBER	REF. NUMBER	VOLTAGE VAC (-)	CURRENT (A)	PKG
FR10AM40V2P	Z084984	400VAC	2A	10
FR10AM40V4P	Y085259	400VAC	4A	10
FR10AM40V6P	W085257	400VAC	6A	10
FR10AM40V8P	A084985	400VAC	8A	10
FR10AM40V10P	B084986	400VAC	10A	10
FR10AM40V12P	X085258	400VAC	12A	10
FR10AM40V16P	C084757	400VAC	16A	10
FR10AM40V20P	V085256	400VAC	20A	10
FR10AM25V25P	A076038	250VAC	25A	10
FR10AM25V32P	B076039	250VAC	32A	10

690 VAC
Breaking capacity: 120 kA

W/o indication

CAT. NUMBER	REF. NUMBER	VOLTAGE VAC (-)	CURRENT (A)	PKG
FR10AM69V1	H302779	690VAC	1A	10
FR10AM69V2	J302780	690VAC	2A	10
FR10AM69V4	K302781	690VAC	4A	10
FR10AM69V6	L302782	690VAC	6A	10
FR10AM69V8	M302783	690VAC	8A	10
FR10AM69V10	N302784	690VAC	10A	10
FR10AM69V12	P302785	690VAC	12A	10

Neutral link

CAT. NUMBER	REF. NUMBER	PKG
FRN1038	R211569	10



LOW VOLTAGE CYLINDRICAL FUSES

Fusegear 10x38



**Compact -
CCR10 fuse
holder**



USFM10

NO. OF POLES	CAT. NUMBER	REF. NUMBER	NO. OF MOD.	PKG	LICENCE NF
N	CCR810N	Z214635	1	12	•
1	CCR101	N218213	1	12	•
1+N	CCR1N1M	H215655	1	12	•
2	CCR102	X233723	2	6	
3	CCR103	Y233724	3	4	

NO. OF POLES	CAT. NUMBER	REF. NUMBER	NO. OF MOD.	PKG
3	USFM10	K1027235	45 mm	1
3	USFM10M	M1027237	45 mm	1
3	USFM10I	L1027236	45 mm	1
3	USFM10MI	N1027238	45 mm	1



Modulostar® CMS/US10

CCD CONFIGURATIONS	CAT. NUMBER W/O INDICATION	REF. NUMBER W/O INDICATION	CAT. NUMBER WITH INDICATION	REF. NUMBER WITH INDICATION	PKG
1	CMS101	T305020	CMS101I	A305026	12
1+N	CMS101N	V305021	CMS101NI	B305027	6
2	CMS102	W305022	CMS102I	C305028	6
3	CMS103	X305023	CMS103I	D305029	4
3+N	CMS103N	Y305024	CMS103NI	E305030	3
4	CMS104	Z305025	CMS104I	F305031	3



Switch fuse disconnectors

DESCRIPTION	CAT. NUMBER	REF. NUMBER	WEIGHT	PKG
Switch.fus 25A FR10 1+2 pos.	M25F12	H1043264	0.70	1
Switch.fus 25A FR10 R side op.	M25F30S	L1043267	1.2	1.2

LOW VOLTAGE CYLINDRICAL FUSES

Size 14x51



gG

500/690 VAC
Breaking capacity: 120 kA

W/o indication

CAT. NUMBER	REF. NUMBER	VOLTAGE VAC (-)	CURRENT (A)	PKG
FR14GG69V1	K218716	690VAC	1A	10
FR14GG69V2	Y219234	690VAC	2A	10
FR14GG69V4	A219765	690VAC	4A	10
FR14GG69V6	H222210	690VAC	6A	10
FR14GG69V8	D222965	690VAC	8A	10
FR14GG69V10	L200754	690VAC	10A	10
FR14GG69V12	L201812	690VAC	12A	10
FR14GG69V16	A211554	690VAC	16A	10
FR14GG69V20	Z212588	690VAC	20A	10
FR14GG69V25	C213603	690VAC	25A	10
FR14GG50V32	W216656	500VAC	32A	10
FR14GG50V40	X218198	500VAC	40A	10
FR14GG50V50	Z219235	500VAC	50A	10

500 VAC
Breaking capacity: 120 kA

With striker

CAT. NUMBER	REF. NUMBER	VOLTAGE VAC (-)	CURRENT (A)	PKG
FR14GG50V2P	J211033	500VAC	2A	10
FR14GG50V4P	H212067	500VAC	4A	10
FR14GG50V6P	G214113	500VAC	6A	10
FR14GG50V8P	R215134	500VAC	8A	10
FR14GG50V10P	Z216153	500VAC	10A	10
FR14GG50V12P	L217176	500VAC	12A	10
FR14GG50V16P	Z218200	500VAC	16A	10
FR14GG50V20P	B219237	500VAC	20A	10
FR14GG50V25P	L222213	500VAC	25A	10
FR14GG50V32P	P200757	500VAC	32A	10
FR14GG50V40P	P201815	500VAC	40A	10
FR14GG50V50P	D211557	500VAC	50A	10



aM

500/690 VAC
Breaking capacity: 120 kA

W/o indication

CAT. NUMBER	REF. NUMBER	VOLTAGE VAC (-)	CURRENT (A)	PKG
FR14AM69V0.25	B212590	690VAC	0.25A	10
FR14AM69V0.5	L213105	690VAC	0.5A	10
FR14AM69V1	E213605	690VAC	1A	10
FR14AM69V2	H214114	690VAC	2A	10
FR14AM69V4	K214622	690VAC	4A	10
FR14AM69V6	S215135	690VAC	6A	10
FR14AM69V8	T215642	690VAC	8A	10
FR14AM69V10	Z216659	690VAC	10A	10
FR14AM69V12	M217177	690VAC	12A	10
FR14AM69V16	Q217686	690VAC	16A	10
FR14AM69V20	P218720	690VAC	20A	10
FR14AM69V25	E219769	690VAC	25A	10
FR14AM50V32	M222214	500VAC	32A	10
FR14AM50V40	Q200758	500VAC	40A	10
FR14AM50V45	L211035	500VAC	45A	10
FR14AM50V50	E211558	500VAC	50A	10

500 VAC
Breaking capacity: 120 kA

With striker

CAT. NUMBER	REF. NUMBER	VOLTAGE VAC (-)	CURRENT (A)	PKG
FR14AM50V1P	W215644	500VAC	1A	10
FR14AM50V2P	B216661	500VAC	2A	10
FR14AM50V4P	C218203	500VAC	4A	10
FR14AM50V6P	E219240	500VAC	6A	10
FR14AM50V8P	N222215	500VAC	8A	10
FR14AM50V10P	S200760	500VAC	10A	10
FR14AM50V12P	R201817	500VAC	12A	10
FR14AM50V16P	G211560	500VAC	16A	10
FR14AM50V20P	E212593	500VAC	20A	10
FR14AM50V25P	H213608	500VAC	25A	10
FR14AM50V32P	N214625	500VAC	32A	10
FR14AM50V40P	X215645	500VAC	40A	10
FR14AM50V45P	C216662	500VAC	45A	10
FR14AM50V50P	D218204	500VAC	50A	10

Neutral link

CAT. NUMBER	REF. NUMBER	PKG
FRN1451	M212600	10

LOW VOLTAGE CYLINDRICAL FUSES

Fusegear 14x51



Compact - CC14

NO. OF POLES	CAT. NUMBER	REF. NUMBER	WEIGHT (G)	PKG
1	CC141	S219781	113	12

Compact - CC14 DIN Rail mounting

NO. OF POLES	CAT. NUMBER	REF. NUMBER	WEIGHT (G)	PKG
1	CC141R	Z211047	113	12



Modulostar® CMS/US14

CCD CONFIGURATIONS	CAT. NUMBER W/O INDICATION	REF. NUMBER W/O INDICATION	CAT. NUMBER WITH INDICATION	REF. NUMBER WITH INDICATION	PKG
1	CMS141	A331016	CMS141I	L331049	6
1+N	CMS141N	T331010	CMS141NI	M331050	3
2	CMS142	R331031	CMS142I	M331004	3
3	CMS143	S331032	CMS143I	K331071	2
3+N	CMS143N	D331042	CMS143NI	Q331007	1
4	CMS144	F331021	-	-	1
N	CMS14N	T331056	-	-	6
With microswitches for fuses with striker (+ pre-isolation)					
1	CMS141M	Z331038	CMS141MI	S331055	6
1+N	CMS141NM	L331026	CMS141NMI	Q331030	6
2 [2 switches]	CMS142M	A331062	CMS142MI	X331036	3
3	CMS143M	F331067	CMS143MI	P331006	2
3 [2 switches]	CMS143M2	H331069	CMS143M2I	Y331037	2
3+N	CMS143NM	E331043	CMS143NMI	H331000	1



Switch fuse disconnectors

DESCRIPTION	CAT. NUMBER	REF. NUMBER	WEIGHT (G)	PKG
Switch.fus 50A FR14 0+3 pos.	M50F03	K1043266	1.3	1
Switch.fus 50A FR14 R side op.	M50F30S	L1043267	1.2	1

LOW VOLTAGE CYLINDRICAL FUSES

Size 22x58



gG

690 VAC

Breaking capacity: 120 kA

W/o indication

CAT. NUMBER	REF. NUMBER	VOLTAGE VAC (-)	CURRENT (A)	PKG
FR22GG69V2	F219241	690VAC	2A	10
FR22GG69V4	H219772	690VAC	4A	10
FR22GG69V6	P222216	690VAC	6A	10
FR22GG69V8	L222972	690VAC	8A	10
FR22GG69V10	T200761	690VAC	10A	10
FR22GG69V12	J201304	690VAC	12A	10
FR22GG69V16	S201818	690VAC	16A	10
FR22GG69V20	P211038	690VAC	20A	10
FR22GG69V25	N212072	690VAC	25A	10
FR22GG69V32	F212594	690VAC	32A	10
FR22GG69V40	J213609	690VAC	40A	10
FR22GG69V50	P214626	690VAC	50A	10
FR22GG69V63	Y215646	690VAC	63A	10
FR22GG69V80	Q217180	690VAC	80A	10
FR22GG50V100	E218205	500VAC	100A	10
FR22GG50V125	J219773	500VAC	125A	10

690 VAC

Breaking capacity: 120 kA

With striker

CAT. NUMBER	REF. NUMBER	VOLTAGE VAC (-)	CURRENT (A)	PKG
FR22GG69V2P	N093760	690VAC	2A	10
FR22GG69V4P	R214628	690VAC	4A	10
FR22GG69V6P	A215648	690VAC	6A	10
FR22GG69V8P	F216665	690VAC	8A	10
FR22GG69V10P	W217691	690VAC	10A	10
FR22GG69V12P	W218726	690VAC	12A	10
FR22GG69V16P	L219775	690VAC	16A	10
FR22GG69V20P	P222975	690VAC	20A	10
FR22GG69V25P	M201307	690VAC	25A	10
FR22GG69V32P	S211041	690VAC	32A	10
FR22GG69V40P	R212075	690VAC	40A	10
FR22GG69V50P	M213612	690VAC	50A	10
FR22GG50V63P	S214629	500VAC	63A	10
FR22GG50V80P	F216159	500VAC	80A	10
FR22GG50V100P	T217183	500VAC	100A	10
FR22GG50V125P	H218208	500VAC	125A	10



aM

690 VAC

Breaking capacity: 120 kA

W/o indication

CAT. NUMBER	REF. NUMBER	VOLTAGE VAC (-)	CURRENT (A)	PKG
FR22AM69V1	M219776	690VAC	1A	10
FR22AM69V2	T222220	690VAC	2A	10
FR22AM69V4	Q222976	690VAC	4A	10
FR22AM69V6	Y200765	690VAC	6A	10
FR22AM69V8	N201308	690VAC	8A	10
FR22AM69V10	X201822	690VAC	10A	10
FR22AM69V12	T211042	690VAC	12A	10
FR22AM69V16	M211565	690VAC	16A	10
FR22AM69V20	S212076	690VAC	20A	10
FR22AM69V25	J212597	690VAC	25A	10
FR22AM69V32	V213113	690VAC	32A	10
FR22AM69V40	N213613	690VAC	40A	10
FR22AM69V50	R214122	690VAC	50A	10
FR22AM69V63	C215650	690VAC	63A	10
FR22AM69V80	H216667	690VAC	80A	10
FR22AM50V100	Y217693	500VAC	100A	10
FR22AM50V125	J218209	500VAC	125A	10

690 VAC

Breaking capacity: 120 kA

With striker

CAT. NUMBER	REF. NUMBER	VOLTAGE VAC (-)	CURRENT (A)	PKG
FR22AM69V1P	E215652	690VAC	1A	10
FR22AM69V2P	J216162	690VAC	2A	10
FR22AM69V4P	A217695	690VAC	4A	10
FR22AM69V6P	Y218728	690VAC	6A	10
FR22AM69V8P	Q219779	690VAC	8A	10
FR22AM69V10P	S222978	690VAC	10A	10
FR22AM69V12P	R201311	690VAC	12A	10
FR22AM69V16P	W211044	690VAC	16A	10
FR22AM69V20P	W212079	690VAC	20A	10
FR22AM69V25P	Q213615	690VAC	25A	10
FR22AM69V32P	X214633	690VAC	32A	10
FR22AM69V40P	F215653	690VAC	40A	10
FR22AM69V50P	K216669	690VAC	50A	10
FR22AM50V63P	B217696	500VAC	63A	10
FR22AM50V80P	Z218729	500VAC	80A	10
FR22AM50V100P	T222979	500VAC	100A	10
FR22AM50V125P	S201312	500VAC	125A	10

Neutral link

CAT. NUMBER	REF. NUMBER	PKG
FRN2258	R213616	10



LOW VOLTAGE CYLINDRICAL FUSES

Fusegear 22x58



Compact - CC22

NO. OF POLES	CAT. NUMBER	REF. NUMBER	WEIGHT (G)	PKG
1	CC221	X214127	189	6

Compact - CC22 DIN Rail mounting

NO. OF POLES	CAT. NUMBER	REF. NUMBER	WEIGHT (G)	PKG
1	CC221R	B217190	189	6



Modulostar® CMS/US22

CCD CONFIGURATIONS	CAT. NUMBER W/O INDICATION	REF. NUMBER W/O INDICATION	CAT. NUMBER WITH INDICATION	REF. NUMBER WITH INDICATION	PKG
1	CMS221	T331079	CMS221I	B331086	6
1+N	CMS221N	H331092	CMS221NI	W1001462	3
2	CMS222	Q331122	CMS222I	D331134	3
3	CMS223	E331135	CMS223I	D331134	2
3+N	CMS223N	A331108	CMS223NI	N1001455	1
4	CMS224	Q331099			1
N	CMS22N	K331094			6
With microswitches for fuses with striker (+ pre-isolation)					
1	CMS221M	S331078	CMS221MI	N331074	6
1+N	CMS221NM	W1016642	CMS221NMI	N1016589	3
2 (2 switches)	CMS222M	V331080	CMS222MI	P331098	3
3	CMS223M	B331109	CMS223MI	E331112	2
3 (2 switches)	CMS223M2	C331087	CMS223M2I	E331112	2
3+N	CMS223NM	T331102	CMS223NMI	W331104	1









Switch fuse disconnectors

DESCRIPTION	CAT. NUMBER	REF. NUMBER	WEIGHT (G)	PKG
Switch.fus 125A FR22 0+3 pos.	M125F03	P1043270	1.5	1
Switch.fus 125A FR22 R side op.	M125F30S	Q1043271	1.6	1

NH FUSES AND FUSEGEAR OFFERING

NH fuses

SIZE	VOLTAGE*	BREAKING CAPACITY	FUSES		BASES
			GG	AM	
			WITH DOUBLE INDICATION	WITH DOUBLE INDICATION	
 000	400VAC	100kA	2 - 100A	–	
	500VAC / 250VDC	120kA / 80kA	2 - 100A	2 - 80A	
	690VAC	80kA	2 - 80A	2 - 63A	
 00	400VAC	100kA	125 - 160A	–	
	500VAC / 250VDC	120kA / 80kA	125 - 160A	100 - 160A	
	690VAC	80kA	32 - 125A	50 - 125A	
 0	400VAC	100kA	–	–	
	500VAC / 250VDC	120kA / 80kA	6 - 250A	100 - 200A	
	690VAC / 400VDC	80kA / 80kA	10 - 160A	10 - 160A	
 1	400VAC	100kA	35 - 250A	–	
	500VAC / 250VDC	120kA / 80kA	16 - 355A	100 - 315A	
	690VAC / 400VDC	80kA / 80kA	16 - 250A	16 - 250A	
 2	400VAC	100kA	35 - 400A	–	
	500VAC / 250VDC	120kA / 80kA	25 - 500A	25 - 500A	
	690VAC	80kA	32 - 355A	35 - 400A	
 3	400VAC	100kA	250 - 630A	–	
	500VAC / 250VDC	120kA / 80kA	100 - 630A	315 - 630A	
	690VAC	80kA	250 - 500A	250 - 500A	

* DC voltage for NH gG fuses

Fusegear

SWITCH FUSE DISCONNECTORS	FUSE SWITCH DISCONNECTORS	ACCESSORIES	PAGES
 <p>M63D03</p>	 <p>Multibloc®</p>		18-19
 <p>M400D</p>	 <p>Multibloc®</p>	 <p>Pull handle</p>	20-21
 <p>M630D</p>	 <p>Multivert®</p>	 <p>Neutral link</p>	22-23
	 <p>Multifix 60</p>		24-26
			27-29
			30-31

NH FUSES

Size 000



400 VAC
Breaking capacity: 100 kA

With double indication

CAT. NUMBER	REF. NUMBER	CURRENT (A)	WITH DOUBLE INDICATION	PKG
NH000GG40V2	Z223674	2	2 - 100A	3
NH000GG40V4	A223675	4		3
NH000GG40V6	B223676	6		3
NH000GG40V10	C223677	10		3
NH000GG40V16	D223678	16		9
NH000GG40V20	E223679	20		9
NH000GG40V25	F223680	25		9
NH000GG40V32	G223681	32		9
NH000GG40V35	H223682	35		9
NH000GG40V40	J223683	40		9
NH000GG40V50	K223684	50		9
NH000GG40V63	L223685	63		9
NH000GG40V80	M223686	80		9
NH000GG40V100	N223687	100		9

500 VAC / 250 VDC
Breaking capacity:
120 kA / 80kA

With double indication

CAT. NUMBER	REF. NUMBER	CURRENT (A)	WITH DOUBLE INDICATION	PKG
NH000GG50V2	B211946	2	2 - 100A	3
NH000GG50V4	M212462	4		3
NH000GG50V6	D213995	6		3
NH000GG50V10	B219651	10		3
NH000GG50V16	K222097	16		9
NH000GG50V20	A222847	20		9
NH000GG50V25	E201185	25		9
NH000GG50V32	Z211438	32		9
NH000GG50V35	C211947	35		9
NH000GG50V40	N212463	40		9
NH000GG50V50	T212974	50		9
NH000GG50V63	E213996	63		9
NH000GG50V80	Y216543	80		9
NH000GG50V100	B219122	100		9



690 VAC
Breaking capacity: 80 kA

With double indication

CAT. NUMBER	REF. NUMBER	CURRENT (A)	WITH DOUBLE INDICATION	PKG
NH000GG69V2	E228440	2	2 - 80A	3
NH000GG69V4	F228441	4		3
NH000GG69V6	G228442	6		3
NH000GG69V10	J228444	10		3
NH000GG69V16	K228445	16		3
NH000GG69V20	L228446	20		3
NH000GG69V25	M228447	25		3
NH000GG69V32	N228448	32		3
NH000GG69V35	P228449	35		3
NH000GG69V40	Q228450	40		3
NH000GG69V50	R228451	50		3
NH000GG69V63	S228452	63		3
NH000GG69V80	T228453	80		3

Fusegear

**IEC Switch fuse
disconnecter: M63D**



63A, NH fuses

DESCRIPTION	CAT. NUMBER	REF. NUMBER	WEIGHT (G)	PKG
Switch.fus 63A 000 0+3 pos.	M63D03	M1043268	1.3	1
Switch.fus 63A 000 R side op.	M63D30S	N1043269	1.2	1

NH FUSES

Size 000



aM

500 VAC
Breaking capacity: 120 kA

With double indication

CAT. NUMBER	REF. NUMBER	CURRENT (A)	WITH DOUBLE INDICATION	PKG
NH000AM50V2	K232493	2	2 - 80A	3
NH000AM50V4	L232494	4		3
NH000AM50V6	M232495	6		3
NH000AM50V10	N232496	10		3
NH000AM50V16	P232497	16		3
NH000AM50V20	Q232498	20		3
NH000AM50V25	R232499	25		3
NH000AM50V32	S232500	32		3
NH000AM50V35	T232501	35		3
NH000AM50V40	V232502	40		3
NH000AM50V50	W232503	50		3
NH000AM50V63	X232504	63		3
NH000AM50V80	C227863	80		9



aM

690 VAC
Breaking capacity: 80 kA

With double indication

CAT. NUMBER	REF. NUMBER	CURRENT (A)	WITH DOUBLE INDICATION	PKG
NH000AM69V2	P227851	2	2 - 63A	3
NH000AM69V4	Q227852	4		3
NH000AM69V6	R227853	6		3
NH000AM69V10	S227854	10		3
NH000AM69V16	T227855	16		3
NH000AM69V20	V227856	20		3
NH000AM69V25	W227857	25		3
NH000AM69V32	X227858	32		3
NH000AM69V35	Y227859	35		3
NH000AM69V40	Z227860	40		3
NH000AM69V50	A227861	50		3
NH000AM69V63	B227862	63		3



ep.mersen.com

Fusegear

MULTIBLOC® 000.ST8



100A, 690VAC, bottom fitting, 3 poles

CAT. NUMBER	REF. NUMBER	POLES	CABLE TERMINATION COMPONENTS	WEIGHT KG ¹	PKG
C00ST601	J1002118	3	6 frame clamps 1,5–50mm ²	0.46	1

MULTIBLOC® 000.RST8



100 A, 690 V AC, bus bar installation, 3 poles

CAT. NUMBER	REF. NUMBER	POLES	CABLE TERMINATION COMPONENTS	WEIGHT KG ¹	PKG
1.002.571	L1002166	3	3 frame clamps 2,5-50 mm ² bottom terminal	0.60	1
1.002.572	L1023050	3	3 frame clamps 2,5-50 mm ² top terminal	0.62	1

Accessories

Pull handle



Neutral link



DESCRIPTION	CAT. NUMBER	REF. NUMBER	PKG
Neutral link size 000	NH00NEUTRAL	Z218269	15
Isolated neutral link size 000	NH00DKNIFESGP	W216058	12
Pull handle	NHHANDLE	P215592	5

1) Weight in kg per piece or set including package

NH FUSES

Size 00



gG

400 VAC

Breaking capacity: 100 kA

With double indication

CAT. NUMBER	REF. NUMBER	CURRENT (A)	WITH DOUBLE INDICATION	PKG
NH00GG40V125	E223702	125	125-160A	3
NH00GG40V160	F223703	160		3

500 VAC / 250 VDC

**Breaking capacity:
120 kA / 80 kA**

With double indication

CAT. NUMBER	REF. NUMBER	CURRENT (A)	WITH DOUBLE INDICATION	PKG
NH00GG50V125	R201863	125	125-160A	3
NH00GG50V160	P211084	160		3

690 VAC

Breaking capacity: 80 kA

With double indication

CAT. NUMBER	REF. NUMBER	CURRENT (A)	WITH DOUBLE INDICATION	PKG
NH00GG69V32	V228454	32	32-125A	3
NH00GG69V35	W228455	35		3
NH00GG69V40	X228456	40		3
NH00GG69V50	Y228457	50		3
NH00GG69V63	Z228458	63		3
NH00GG69V80	A228459	80		3
NH00GG69V100	B228460	100		3
NH00GG69V125	C228461	125		3



aM

500 VAC

Breaking capacity: 120 kA

With double indication

CAT. NUMBER	REF. NUMBER	CURRENT (A)	WITH DOUBLE INDICATION	PKG
NH00AM50V100	Y232505	100	100-160A	3
NH00AM50V125	Z232506	125		3
NH00AM50V160	J227869	160		3

690 VAC

Breaking capacity: 80 kA

With double indication

CAT. NUMBER	REF. NUMBER	CURRENT (A)	WITH DOUBLE INDICATION	PKG
NH00AM69V50	D227864	50	50-125A	3
NH00AM69V63	E227865	63		3
NH00AM69V80	F227866	80		3
NH00AM69V100	G227867	100		3
NH00AM69V125	H227868	125		3



Accessories

Pull handle



Neutral link



DESCRIPTION	CAT. NUMBER	REF. NUMBER	PKG
Neutral link size 00	NH00NEUTRAL	Z218269	15
Isolated neutral link size 00	NH00DKNIFESGP	W216058	12
Pull handle	NHHANDLE	P215592	5

NH FUSES

Fusegear

Size 00 - NH plastic base



NO. OF POLES	MOUNTING TYPE	CAT. NUMBER	REF. NUMBER	PKG
1	DIN rail	BB001EPR	R216192	3
1	Screw	BB001EP	F215170	3
3	DIN rail	BB003EPRBLOC	V229121	1
3	Screw	BB003EPVBLOC	W229122	1
Insulating barriers		BB00CL	W212654	2

IEC Switch fuse disconnecter: M160D



160A, NH fuses



MULTIBLOC® 00



1.000.053



2.030.000



3.084.000

160A, 690VAC

CAT. NUMBER	REF. NUMBER	POLES	CABLE TERMINATION COMPONENTS	DESIGN	WEIGHT (KG) ¹⁾	PKG
1.000.053	F229292	1	2 M8 terminal screws	ST8 - bottom fitting	0.32	1
1.000.139	G229293	2	3 M8 terminal screws	ST8 - bottom fitting	0.62	1
2.030.000	P1023007	3	6 M8 terminal screws	ST9 - bottom fitting	0.75	1
2.031.000	E1023044	3	6 clamp straps Cu 4-70mm ²	ST9 - bottom fitting	0.75	1
2.031.300	F1023045	3	6 clamp straps Cu 4-70mm ²	ST9 - bottom fitting Fixed window to protect against unauthorized connection	0.75	1
2.030.100	V1023012	3	6 M8 terminal screws	ST9 - bottom fitting with electronic monitoring of fuse	0.86	1
3.084.000	Z1022993	3	3 M8 terminal screws 3 clamp straps Cu 4-70mm ²	RST9 - snap-on mounting on busbar 60mm	0.93	1
3.083.000	X1022991	3	3 frame clamps Cu 2,5-70 mm ² factory assembled	RST9 - snap-on mounting on busbar 60mm	0.88	1
3.084.100	B1022995	3	3M8 terminal screws 3 clamp straps Cu 4-70mm ²	RST9 - snap-on mounting on busbar 60mm with electronic monitoring of fuse	0.96	1
2.074.000	W1022990	3	3M8 terminal screws 3 clamp straps Cu 4-70mm ²	RST9 - mounting on busbar 40mm clamping bar	1.06	1
1.000.141	J1023002	4	8 M8 terminal screws	ST8 - bottom fitting, pole 4 right side	1.04	1
1.000.142	K1023003	4	8 clamp straps Cu 4-70mm ²	ST8 - bottom fitting, pole 4 right side	1.04	1

MULTIVERT® 160 A



1.000.900



1.000.909



MZ00DSA

MULTIVERT® 160 A size 00 bus bar system 1 x triple pole switching

CAT. NUMBER	REF. NUMBER	POLES	CABLE TERMINATION COMPONENTS	DESIGN	WEIGHT (KG) ¹⁾	PKG
1.000.900	F1002184	1 x 3P	3 M8 terminal screws	mounting on busbar 100mm	1.17	1
1.000.901	X1023129	1 x 3P	3 clamp straps Cu 4-70 mm ²	mounting on busbar 100mm	1.12	1
1.000.903	A1023132	1 x 3P	with V-terminal for V-terminal clamps size 00	mounting on busbar 100mm	1.12	1
1.000.909	E1002183	1 x 3P	3 M8 terminal screws/3 clamp straps 4-70 mm ²	mounting on busbar 60mm	1.365	1

Adapter for installation on to bus bars with screw terminal

CAT. NUMBER	REF. NUMBER	DESIGN	WEIGHT (KG) ¹⁾	PKG
MZ00DSA	C217145	double adapter 100/185 mm	0.706	1

1) Weight in kg per piece or set including package

Size 0



gG

500 VAC / 250 VDC
Breaking capacity:
120 kA / 80 kA

With double indication

CAT. NUMBER	REF. NUMBER	CURRENT (A)	WITH DOUBLE INDICATION	PKG
NH0GG50V6	H213148	6	6-250A	3
NH0GG50V10	G214159	10		3
NH0GG50V16	Q215179	16		3
NH0GG50V20	R215686	20		3
NH0GG50V25	Y216198	25		3
NH0GG50V32	W216702	32		3
NH0GG50V35	J217220	35		3
NH0GG50V40	P217731	40		3
NH0GG50V50	Z218246	50		3
NH0GG50V63	N218765	63		3
NH0GG50V80	C219284	80		3
NH0GG50V100	D219814	100		3
NH0GG50V125	P222492	125		3
NH0GG50V160	F223013	160		3
NH0GG50V200	C229611	200		3
NH0GG50V224	D229612	224	3	
NH0GG50V250	E229613	250	3	



gG

690 VAC / 400 VDC
Breaking capacity:
80 kA / 80 kA

With double indication

CAT. NUMBER	REF. NUMBER	CURRENT (A)	WITH DOUBLE INDICATION	PKG
NH0GG69V10	E228463	10	10-160A	3
NH0GG69V16	F228464	16		3
NH0GG69V20	G228465	20		3
NH0GG69V25	H228466	25		3
NH0GG69V32	J228467	32		3
NH0GG69V35	K228468	35		3
NH0GG69V40	L228469	40		3
NH0GG69V50	M228470	50		3
NH0GG69V63	N228471	63		3
NH0GG69V80	P228472	80		3
NH0GG69V100	Q228473	100		3
NH0GG69V125	R228474	125		3
NH0GG69V160	S228475	160	3	



ep.mersen.com



aM

500 VAC
Breaking capacity: 120 kA

With double indication

CAT. NUMBER	REF. NUMBER	CURRENT (A)	WITH DOUBLE INDICATION	PKG
NH0AM50V100	A232507	100	100-200A	3
NH0AM50V125	B232508	125		3
NH0AM50V160	C232509	160		3
NH0AM50V200	A227884	200		3



aM

690 VAC
Breaking capacity: 80 kA

With double indication

CAT. NUMBER	REF. NUMBER	CURRENT (A)	WITH DOUBLE INDICATION	PKG
NH0AM69V10	L227871	10	100-160A	3
NH0AM69V16	M227872	16		3
NH0AM69V20	N227873	20		3
NH0AM69V25	P227874	25		3
NH0AM69V32	Q227875	32		3
NH0AM69V35	R227876	35		3
NH0AM69V40	S227877	40		3
NH0AM69V50	T227878	50		3
NH0AM69V63	V227879	63		3
NH0AM69V80	W227880	80		3
NH0AM69V100	X227881	100		3
NH0AM69V125	Y227882	125		3
NH0AM69V160	Z227883	160	3	

NH FUSES

Fusegear

Size 0 - NH plastic base



NO. OF POLES	MOUNTING TYPE	CAT. NUMBER	REF. NUMBER	PKG
1	DIN rail	BB01EPR	S216193	3
1	Screw	BB01EP	B213142	3
3	DIN rail	BB03EPR	C217214	1
3	Screw	BB03EP	G215171	1
Insulating barriers		BB0CL	Z213669	2



ep.mersen.com

IEC Switch fuse disconnecter: M200D



200A, NH fuses

DESCRIPTION	CAT. NUMBER	REF. NUMBER	WEIGHT (G)	PKG
Switch.fus 200A 0 0+3 pos.	M200D03	T1043274	3.3	1
Switch.fus 200A 0 R side op.	M200D30S	V1043275	3.3	1

IEC Switch fuse disconnecter: M250D



250A, NH fuses

DESCRIPTION	CAT. NUMBER	REF. NUMBER	WEIGHT (G)	PKG
Switch.fus 250A 0-1 0+3 pos.	M250D03	W1043276	3.93	1
Switch.fus 250A 0-1 R side op.	M250D30S	X1043277	4.15	1

IEC Switch fuse disconnecter: M400D



400A, NH fuses

DESCRIPTION	CAT. NUMBER	REF. NUMBER	WEIGHT (G)	PKG
Switch.fus 400A 0-2 0+3 pos.	M400D03	Y1043278	7.1	1
Switch.fus 400A 0-2 R side op.	M400D30S	Z1043279	7.18	1

Accessories

Pull handle



Neutral link



DESCRIPTION	CAT. NUMBER	REF. NUMBER	PKG
Neutral link size 0	NH0NEUTRAL	Z219304	15
Isolated neutral link size 0	NH0DKNIFESGP	J217082	12
Pull handle	NHHANDLE	P215592	5

1) Weight in kg per piece or set including package

NH FUSES

Size 1



gG

400 VAC
Breaking capacity: 100 kA

With double indication

SIZE	CAT. NUMBER	REF. NUMBER	CURRENT (A)	WITH DOUBLE INDICATION	PKG
1C	NH1GG40V35	J223706	35	35-250A	3
1C	NH1GG40V50	K223707	50		3
1C	NH1GG40V63	L223708	63		3
1C	NH1GG40V80	M223709	80		3
1C	NH1GG40V100	N223710	100		3
1C	NH1GG40V125	P223711	125		3
1	NH1GG40V160	Q223712	160		3
1	NH1GG40V200	R223713	200		3
1	NH1GG40V224	S223714	224		3
1	NH1GG40V250	T223715	250		3

500 VAC / 250 VDC
Breaking capacity:
120 kA / 80 kA

With double indication

SIZE	CAT. NUMBER	REF. NUMBER	CURRENT (A)	WITH DOUBLE INDICATION	PKG
1C	NH1GG50V16	M200801	16	16-355A	3
1C	NH1GG50V20	C201344	20		3
1C	NH1GG50V25	N201860	25		3
1C	NH1GG50V32	L211081	32		3
1C	NH1GG50V35	A211600	35		3
1C	NH1GG50V40	Y212633	40		3
1C	NH1GG50V50	B213648	50		3
1C	NH1GG50V63	L214669	63		3
1C	NH1GG50V80	S215687	80		3
1C	NH1GG50V100	X216703	100		3
1C	NH1GG50V125	V236044	125		3
1	NH1GG50V160	A218247	160		3
1	NH1GG50V200	P218766	200		3
1	NH1GG50V224	D219285	224		3
1	NH1GG50V250	E219815	250		3
1	NH1GG50V315	Q228519	315		3
1	NH1GG50V355	R228520	355		3



gG

690 VAC / 400 VDC
Breaking capacity:
80 kA / 80 kA

With double indication

SIZE	CAT. NUMBER	REF. NUMBER	CURRENT (A)	WITH DOUBLE INDICATION	PKG
1C	NH1GG69V16	T228476	16	16-250A	3
1C	NH1GG69V20	V228477	20		3
1C	NH1GG69V25	W228478	25		3
1C	NH1GG69V32	X228479	32		3
1C	NH1GG69V35	Y228480	35		3
1C	NH1GG69V40	Z228481	40		3
1C	NH1GG69V50	A228482	50		3
1C	NH1GG69V63	B228483	63		3
1C	NH1GG69V80	C228484	80		3
1C	NH1GG69V100	D228485	100		3
1	NH1GG69V125	E228486	125		3
1	NH1GG69V160	F228487	160		3
1	NH1GG69V200	G228488	200		3
1	NH1GG69V224	V233261	224		3
1	NH1GG69V250	W233262	250		3



NH FUSES

Size 1



aM

500 VAC
Breaking capacity: 120 kA

With double indication

CAT. NUMBER	REF. NUMBER	CURRENT (A)	WITH DOUBLE INDICATION	PKG
NH1AM50V100	D232510	100	100-315A	3
NH1AM50V125	E232511	125		3
NH1AM50V160	F232512	160		3
NH1AM50V200	G232513	200		3
NH1AM50V224	H232514	224		3
NH1AM50V250	J232515	250		3
NH1AM50V315	K227962	315		3



ep.mersen.com



aM

690 VAC
Breaking capacity: 80 kA

With double indication

CAT. NUMBER	REF. NUMBER	CURRENT (A)	WITH DOUBLE INDICATION	PKG
NH1AM69V16	B227885	16	16-250A	3
NH1AM69V25	D227887	25		3
NH1AM69V32	E227888	32		3
NH1AM69V35	F227889	35		3
NH1AM69V40	G227890	40		3
NH1AM69V50	H227891	50		3
NH1AM69V63	J227892	63		3
NH1AM69V80	K227893	80		3
NH1AM69V100	L227894	100		3
NH1AM69V125	M227895	125		3
NH1AM69V160	N227896	160		3
NH1AM69V200	P227897	200		3
NH1AM69V224	Q227898	224		3
NH1AM69V250	R227899	250		3

Fusegear

Size 1 - NH plastic base



NO. OF POLES	MOUNTING TYPE	CAT. NUMBER	REF. NUMBER	PKG
1	DIN rail	BB11PPR	A223008	3
1	Screw	BB11PP	E218757	3
3	DIN rail	BB13PPR	Y201340	1
3	Screw	BB13PP	Y223006	1
Insulating barriers		BB1-2PPCL	J214690	2

Accessories

Pull handle



Neutral link



DESCRIPTION	CAT. NUMBER	REF. NUMBER	PKG
Neutral link size 1	NH1NEUTRAL	A219834	9
Isolated neutral link size 1	NH1DKNIFESGP	Y218107	12
Pull handle	NHHANDLE	P215592	5

NH FUSES

Fusegear



IEC Switch fuse disconnecter: M250D



250A, NH fuses

DESCRIPTION	CAT. NUMBER	REF. NUMBER	WEIGHT (G)	PKG
Switch.fus 250A 0-1 0+3 pos.	M250D03	W1043276	3.93	1
Switch.fus 250A 0-1 R side op.	M250D30S	X1043277	4.15	1

IEC Switch fuse disconnecter: M400D



400A, NH fuses

DESCRIPTION	CAT. NUMBER	REF. NUMBER	WEIGHT (G)	PKG
Switch.fus 400A 0-2 0+3 pos.	M400D03	Y1043278	7.1	1
Switch.fus 400A 0-2 R side op.	M400D30S	Z1043279	7.18	1

MULTIBLOC® 1



1.000.388



1.000.299



1.000.323

250A, 690VAC

CAT. NUMBER	REF. NUMBER	POLES	CABLE TERMINATION COMPONENTS	DESIGN	WEIGHT (KG) ¹	PKG
1.000.388	Q229876	1	2 M10 terminal screws	ST8 - bottom fitting	1.00	1
1.000.397	R229877	2	4 M10 terminal screws	ST8 - bottom fitting	2.06	1
1.000.299	S229878	3	6 M10 terminal screws	ST8 - bottom fitting	2.42	1
1.002.562	W1023059	3	6 clamp straps 70-150mm ²	ST8 - bottom fitting	2.42	1
1.002.711	X1023060	3	6 M10 terminal screws	ST8 - bottom fitting with electronic monitoring of fuse	2.64	1
1.000.323	T229879	3	3 M10 terminal screws	RST8 - mounting on busbar	3.09	1
1.001.294	Q1023054	3	3 clamp straps 70-150mm ²	RST8 - mounting on busbar	3.06	1
1.003.134	R1023055	3	3 M10 terminal screws	RST8 - mounting on busbar with electronic monitoring of fuse	3.14	1
1.000.405	Y1023061	4	8 M10 terminal screws	ST8 - bottom fitting	3.4	1

MULTIVERT® 250 A



1.100.000



1.170.000

MULTIVERT® 250 A size 1 185 mm

CAT. NUMBER	REF. NUMBER	POLES	CABLE TERMINATION COMPONENTS	DESIGN	WEIGHT (KG) ¹	PKG
1.100.000	H1002186	3 x 1P	3 M10 bolts	mounting on busbar 185 mm	4.52	1
1.110.000	J1023163	3 x 1P	3 M10 insert nuts	mounting on busbar 185 mm	4.46	1
1.120.000	K1023164	3 x 1P	V-terminal for V-terminal clamps size 1,2,3	mounting on busbar 185 mm	4.38	1
1.150.000	L1002189	1 x 3P	3 M10 bolts	mounting on busbar 185 mm	4.55	1
1.160.000	S1023171	1 x 3P	3 M10 insert nuts	mounting on busbar 185 mm	4.63	1
1.170.000	H1023185	1 x 3P	V-terminal for V-terminal clamps size 1,2,3	mounting on busbar 185 mm	4.55	1

1) Weight in kg per piece or set including package

NH FUSES

Size 2



gG

400 VAC

Breaking capacity: 100 kA

With double indication

SIZE	CAT. NUMBER	REF. NUMBER	CURRENT (A)	WITH DOUBLE INDICATION	PKG
2C	NH2GG40V35	T227257	35	35-400A	3
2C	NH2GG40V50	V227258	50		3
2C	NH2GG40V63	W227259	63		3
2C	NH2GG40V80	F223726	80		3
2C	NH2GG40V100	G223727	100		3
2C	NH2GG40V125	H223728	125		3
2C	NH2GG40V160	J223729	160		3
2C	NH2GG40V200	K223730	200		3
2C	NH2GG40V224	L223731	224		3
2C	NH2GG40V250	M223732	250		3
2	NH2GG40V315	N223733	315		3
2	NH2GG40V355	P223734	355		3
2	NH2GG40V400	Q223735	400		3

500 VAC / 250 VDC

Breaking capacity: 120 kA / 80 kA

With double indication

SIZE	CAT. NUMBER	REF. NUMBER	CURRENT (A)	WITH DOUBLE INDICATION	PKG
2C	NH2GG50V25	N200802	25	25-500A	3
2C	NH2GG50V32	D201345	32		3
2C	NH2GG50V35	P201861	35		3
2C	NH2GG50V40	M211082	40		3
2C	NH2GG50V50	B211601	50		3
2C	NH2GG50V63	Z212634	63		3
2C	NH2GG50V80	C213649	80		3
2C	NH2GG50V100	M214670	100		3
2C	NH2GG50V125	T215688	125		3
2C	NH2GG50V160	Y216704	160		3
2C	NH2GG50V200	R217733	200		3
2C	NH2GG50V224	Q218767	224		3
2C	NH2GG50V250	R222494	250		3
2	NH2GG50V300	P200803	300		3
2	NH2GG50V315	E201346	315		3
2	NH2GG50V355	Q201862	355		3
2	NH2GG50V400	N211083	400		3
2	NH2GG50V425	S228521	425		3
2	NH2GG50V500	T228522	500		3



gG

690 VAC

Breaking capacity: 80 kA

With double indication

SIZE	CAT. NUMBER	REF. NUMBER	CURRENT (A)	WITH DOUBLE INDICATION	PKG
2C	NH2GG69V32	H228489	32	32-355A	3
2C	NH2GG69V35	J228490	35		3
2C	NH2GG69V40	K228491	40		3
2C	NH2GG69V50	L228492	50		3
2C	NH2GG69V63	M228493	63		3
2C	NH2GG69V80	N228494	80		3
2C	NH2GG69V100	P228495	100		3
2C	NH2GG69V125	Q228496	125		3
2C	NH2GG69V160	R228497	160		3
2C	NH2GG69V200	S228498	200		3
2C	NH2GG69V224	T228499	224		3
2C	NH2GG69V250	V228500	250		3
2	NH2GG69V300	W228501	300		3
2	NH2GG69V315	X228502	315		3
2	NH2GG69V355	Y228503	355		3



ep.mersen.com

NH FUSES

Size 2



aM

500 VAC

Breaking capacity: 120 kA

With double indication

CAT. NUMBER	REF. NUMBER	CURRENT (A)	WITH DOUBLE INDICATION	PKG
NH2AM50V250	K232516	25	25-500A	3
NH2AM50V315	L232517	315		3
NH2AM50V355	M232518	355		3
NH2AM50V400	N232519	400		3
NH2AM50V500	C227978	500		3



aM

690 VAC

Breaking capacity: 80 kA

With double indication

CAT. NUMBER	REF. NUMBER	CURRENT (A)	WITH DOUBLE INDICATION	PKG
NH2AM69V35	L227963	35	35-400A	3
NH2AM69V40	M227964	40		3
NH2AM69V50	N227965	50		3
NH2AM69V63	P227966	63		3
NH2AM69V80	Q227967	80		3
NH2AM69V100	R227968	100		3
NH2AM69V125	S227969	125		3
NH2AM69V160	T227970	160		3
NH2AM69V200	V227971	200		3
NH2AM69V224	W227972	224		3
NH2AM69V250	X227973	250		3
NH2AM69V300	Y227974	300		3
NH2AM69V315	Z227975	315		3
NH2AM69V355	A227976	355		3
NH2AM69V400	B227977	400		3

Fusegear

Size 2 - NH plastic base



NO. OF POLES	MOUNTING TYPE	CAT. NUMBER	REF. NUMBER	PKG
1	DIN rail	BB21PPR	E211075	3
1	Screw	BB21PP	F201853	3
3	DIN rail	BB23PPR	D212109	1
3	Screw	BB23PP	B212107	1
Insulating barriers		BB1-2PPCL	J214690	2

Accessories

Pull handle



Neutral link



DESCRIPTION	CAT. NUMBER	REF. NUMBER	PKG
Neutral link size 2	NH2NEUTRAL	N222514	6
Isolated neutral link size 2	NH2DKNIFESGP	E200656	6
Pull handle	NHHANDLE	P215592	5

NH FUSES

Fusegear

IEC Switch fuse disconnecter: M400D



400A, NH fuses

DESCRIPTION	CAT. NUMBER	REF. NUMBER	WEIGHT (G)	PKG
Switch.fus 400A 0-2 0+3 pos.	M400D03	Y1043278	7,1	1
Switch.fus 400A 0-2 R side op.	M400D30S	Z1043279	7,18	1

MULTIBLOC® 2



1.000.504

1.000.704

400A, 690VAC, 3 poles

CAT. NUMBER	REF. NUMBER	POLES	CABLE TERMINATION COMPONENTS	DESIGN	WEIGHT (KG) ¹⁾	PKG
1.000.504	W1002129	3	6 M10 terminal screws	ST8 - bottom fitting	3.50	1
1.002.563	G1023069	3	6 clamp straps 120–240mm ²	ST8 - bottom fitting	3.50	1
1.002.712	H1023070	3	6 M10 terminal screws	ST8 - bottom fitting with electronic monitoring of fuse	3.60	1
1.000.704	M1002167	3	3 M10 terminal screws	RST8 - mounting on busbar	4.77	1
1.001.295	C1023065	3	3 clamp straps 120–240mm ²	RST8 - mounting on busbar	4.61	1
1.003.135	D1023066	3	3 M10 terminal screws	RST8 - mounting on busbar with electronic monitoring of fuse	4.60	1
1.001.688	J1023071	4	8 M10 terminal screws	ST8 - bottom fitting	5.04	1

MULTIVERT® 400 A



1.200.000

1.270.000

MULTIVERT® 400 A size 2 185 mm

CAT. NUMBER	REF. NUMBER	POLES	CABLE TERMINATION COMPONENTS	DESIGN	WEIGHT (KG) ¹⁾	PKG
1.200.000	J1002187	3 x 1P	3 M12 bolts	mounting on busbar 185 mm	4.44	1
1.210.000	Z1023200	3 x 1P	3 M12 insert nuts	mounting on busbar 185 mm	4.52	1
1.220.000	A1023201	3 x 1P	V-terminal for V-terminal clamps size 1,2,3	mounting on busbar 185 mm	4.38	1
1.250.000	M1002190	1 x 3P	3 M12 bolts	mounting on busbar 185 mm	4.653	1
1.260.000	G1023207	1 x 3P	3 M12 insert nuts	mounting on busbar 185 mm	4.68	1
1.270.000	H1023208	1 x 3P	V-terminal for V-terminal clamps size 1,2,3	mounting on busbar 185 mm	4.439	1

1) Weight in kg per piece or set including package

NH FUSES

Size 3



gG

400 VAC
Breaking capacity: 100 kA

With double indication

SIZE	CAT. NUMBER	REF. NUMBER	CURRENT (A)	WITH DOUBLE INDICATION	PKG
3C	NH3GG40V250	R223736	250	250-630A	1
3C	NH3GG40V315	S223737	315		1
3C	NH3GG40V400	T223738	400		1
3	NH3GG40V500	V223739	500		1
3	NH3GG40V630	W223740	630		1

500 VAC / 250 VDC
Breaking capacity: 120 kA / 80 kA

With double indication

SIZE	CAT. NUMBER	REF. NUMBER	CURRENT (A)	WITH DOUBLE INDICATION	PKG
3C	NH3GG50V100	S235168	100	100-630A	1
3C	NH3GG50V125	T235169	125		1
3C	NH3GG50V160	V235170	160		1
3C	NH3GG50V200	W235171	200		1
3C	NH3GG50V224	V233744	224		1
3C	NH3GG50V250	C211602	250		1
3C	NH3GG50V300	A212635	300		1
3C	NH3GG50V315	L213151	315		1
3C	NH3GG50V355	K214162	355		1
3C	NH3GG50V400	T215182	400		1
3	NH3GG50V425	B216201	425		1
3	NH3GG50V450	Z216705	450		1
3	NH3GG50V500	M217223	500		1
3	NH3GG50V630	S217734	630		1

690 VAC
Breaking capacity: 80 kA

With double indication

SIZE	CAT. NUMBER	REF. NUMBER	CURRENT (A)	WITH DOUBLE INDICATION	PKG
3C	NH3GG69V250	Z228504	250	250-500A	1
3C	NH3GG69V300	A228505	300		1
3C	NH3GG69V315	B228506	315		1
3C	NH3GG69V355	C228507	355		1
3	NH3GG69V400	D228508	400		1
3	NH3GG69V425	E228509	425		1
3	NH3GG69V500	F228510	500		1



ep.mersen.com



aM

500 VAC
Breaking capacity: 120 kA

With double indication

CAT. NUMBER	REF. NUMBER	CURRENT (A)	WITH DOUBLE INDICATION	PKG
NH3AM50V315	P232520	315	315-630A	1
NH3AM50V355	Q232521	355		1
NH3AM50V400	R232522	400		1
NH3AM50V425	S232523	425		1
NH3AM50V450	T232524	450		1
NH3AM50V500	V232525	500		1
NH3AM50V630	M227987	630		1



aM

690 VAC
Breaking capacity: 80 kA

With double indication

CAT. NUMBER	REF. NUMBER	CURRENT (A)	WITH DOUBLE INDICATION	PKG
NH3AM69V250	D227979	250	250-500A	1
NH3AM69V300	E227980	300		1
NH3AM69V315	F227981	315		1
NH3AM69V355	G227982	355		1
NH3AM69V400	H227983	400		1
NH3AM69V425	J227984	425		1
NH3AM69V450	K227985	450		1
NH3AM69V500	L227986	500		1

NH FUSES

Fusegear

Size 3 - NH plastic base



NO. OF POLES	MOUNTING TYPE	CAT. NUMBER	REF. NUMBER	PKG
1	DIN rail	BB31PPR	X213644	3
1	Screw	BB31PP	W213643	3
3	DIN rail	BB33PPR	F214664	1
3	Screw	BB33PP	H215172	1
Insulating barriers		BB3PPCL	Q215708	2

Accessories

Pull handle



Neutral link



ep.mersen.com

DESCRIPTION	CAT. NUMBER	REF. NUMBER	PKG
Neutral link size 3	NH3NEUTRAL	E223035	6
Isolated neutral link size 3	NH3DKNIFESGP	J201718	6
Pull handle	NHHANDLE	P215592	5

IEC Switch fuse disconnecter: M630D



630A, NH fuses

DESCRIPTION	CAT. NUMBER	REF. NUMBER	WEIGHT (G)	PKG
Switch.fus 630A 3 0+3 pos.	M630D03	A1043280	13	1
Switch.fus 630A 3 R side op.	M630D30S	B1043281	13.9	1

MULTIBLOC® 3



1.001.125

630A, 690VAC, 3 poles

CAT. NUMBER	REF. NUMBER	POLES	CABLE TERMINATION COMPONENTS	DESIGN	WEIGHT (KG) ¹⁾	PKG
1.001.125	C1002135	3	6 M12 terminal screws	ST8 - bottom fitting	4.94	1
1.002.713	M1023074	3	6 M12 terminal screws	ST8 - bottom fitting with electronic monitoring of fuse	5.50	1
1.001.904	N1023075	4	8 M12 terminal screws	ST8 - bottom fitting	7.44	1

MULTIVERT® 630 A



1.300.000 1.370.000 4.350.000

MULTIVERT® 630 A size 3 185 mm

CAT. NUMBER	REF. NUMBER	POLES	CABLE TERMINATION COMPONENTS	DESIGN	WEIGHT (KG) ¹⁾	PKG
1.300.000	K1002188	3 x 1P	3 M12 bolts	mounting on busbar 185 mm	5.43	1
1.310.000	W1023220	3 x 1P	3 M12 insert nuts	mounting on busbar 185 mm	5.38	1
1.320.000	X1023221	3 x 1P	V-terminal for V-terminal clamps size 1,2,3	mounting on busbar 185 mm	5.21	1
1.350.000	N1002191	1 x 3P	3 M12 bolts	mounting on busbar 185 mm	5.609	1
1.360.000	C1023249	1 x 3P	3 M12 insert nuts	mounting on busbar 185 mm	5.57	1
1.370.000	D1023250	1 x 3P	V-terminal for V-terminal clamps size 1,2,3	mounting on busbar 185 mm	5.39	1
4.350.000	G1056005	1 x 4P (3P+N)	3 M12 bolts	mounting on busbar 185mm	8.9	1
4.370.000	W1058272	1 x 4P (3P+N)	V-terminal for V-terminal clamps	mounting on busbar 185mm	8.9	1

1) Weight in kg per piece or set including package

NH FUSES SYSTEM

Multifix 60

D02 vertical fuse base E18



SIZE	CAT. NUMBER	REF. NUMBER	DESIGN	PKG
D02	1.000.759	H1026635	D0 vertical fuse base with cover	10

Universal busbar carriers



1.002.100



1.002.103

NO. OF POLES	CAT. NUMBER	REF. NUMBER	DESIGN	PKG
3	1.002.100	J1026452	universal busbar carrier for busbar thickness 5-10mm	10
1	1.002.101	K1026453	universal busbar carrier attachable to 1.002.100	10
3	1.002.103	J1026498	end cover for universal busbar carrier	20

Touch protection cover caps, terminal clamp plate



CAT. NUMBER	REF. NUMBER	DESIGN	PKG
1.000.771	L1026431	Protection cover 200x54x42 for clamps 1,5-35mm ²	2
1.000.773	N1026433	Protection cover 200x108x78 for clamps 16-185mm ²	2
1.000.774	P1026434	Bus bar protection plate 54mm	2
1.000.775	N1026479	Bus bar protection plate 108mm	2
SAS01412	E212041	Terminal clamp plate complete 200x84x59mm for busbar thickness 5mm	1
SAS01414	Z211530	Terminal clamp plate complete 200x84x59mm for busbar thickness 10mm	1

Universal terminal clamps



1.000.776



1.000.779



1.000.785

BUSBAR THICKNESS	CAT. NUMBER	REF. NUMBER	DESIGN	PKG
5mm	1.000.776	K200730	Terminal clamp 1,5-16mm ²	10
5mm	1.000.777	V1026462	Terminal clamp 1,5-35mm ²	20
5mm	1.000.778	W1026463	Terminal clamp 1,5-50mm ²	20
5mm	1.000.779	J201787	Terminal clamp 16-70mm ²	10
5mm	1.000.780	V207524	Terminal clamp 16-120mm ²	10
5mm	1.001.157	G1026450	Terminal clamp 16-185mm ²	3
10mm	1.000.781	W219209	Terminal clamp 1,5-16mm ²	10
10mm	1.000.782	A1026490	Terminal clamp 1,5-35mm ²	20
10mm	1.000.783	B1026491	Terminal clamp 1,5-50mm ²	20
10mm	1.000.784	F222185	Terminal clamp 16-70mm ²	10
10mm	1.000.785	B222940	Terminal clamp 16-120mm ²	10
10mm	1.001.158	H1026451	Terminal clamp 16-185mm ²	3



Component adapters for top terminal



CAT.NUMBER	REF.NUMBER	DESIGN	PKG
1.001.072	S1026437	Component adapter, terminal 3x4mm ²	4
1.000.786	Q1026435	Component adapter, terminal 3x6mm ²	4
1.001.073	V1026439	Component adapter, terminal 3x10mm ²	4
1.000.787	R1026436	Component adapter, terminal 3x16mm ²	4

Busbar covers

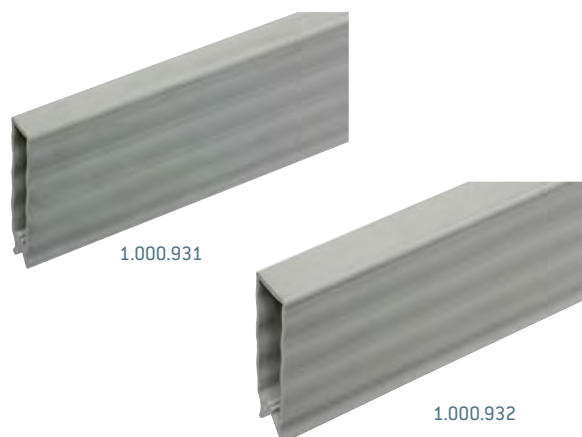

CAT.NUMBER	REF.NUMBER	DESIGN	PKG
1.000.931	V218173	Busbar cover for busbar 5mm	10
1.000.932	X216128	Busbar cover for busbar 10mm	10

Universal supporting bars for component adapter









CAT.NUMBER	REF.NUMBER	DESIGN	PKG
1.000.790	D1026493	supporting bar width 45mm	10
1.000.791	E1026494	supporting bar width 54mm	10
1.000.792	F1026495	supporting bar width 63mm	10
1.000.787	R1026436	Component adapter, terminal 3x16mm ²	4









DO FUSES AND FUSEGEAR OFFERING

Low voltage D0 fuses

Fusegear

SIZE	VOLTAGE	BREAKING CAPACITY	FUSES		
			GG	AM	
			W/O INDICATION	W/O INDICATION	
D01 	400VAC	50kA	2 - 16A		 Neokit
	250VDC	50kA	2 - 16A		
D02  	400VAC	50kA	20 - 63A		 Linocur®
	250VDC	50kA	20 - 63A		
	440VAC	50kA		20 - 35A	
D03 	400VAC	50kA	80 - 100A		—
	250VDC	50kA	80 - 100A		—

Accessories

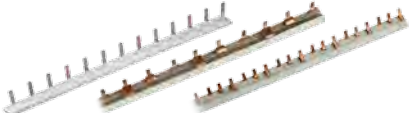
		PAGES	41
		36-37	 <p>Neozed Screw caps porcelain</p>
 <p>Innozed D02/D02</p>	 	38-39	 <p>Neozed Screw caps plastic</p>  <p>Neozed Gauge rings</p>  <p>Neozed space holder insert</p>
	 <p>Neozed fuse bases</p>	40	 <p>Neozed Special holding spring</p>  <p>Insulated wiring bars</p>

LOW VOLTAGE D0 FUSES

Neozed gG - D01



400 VAC - 250 VDC
Breaking capacity: 50 kA

CAT. NUMBER	REF. NUMBER	CURRENT (A)	COLOR CODE	PKG
D01GG40V2	T214676	2	pink	50
D01GG40V4	W200809	4	brown	50
D01GG40V6	B215695	6	green	50
D01GG40V10	W211090	10	red	50
D01GG40V13	C201206	13	black	50
D01GG40V16	R223023	16	grey	50



Fusegear - D01



Neokit
Switchable
fuse base
for D01

NO. OF POLES	VOLTAGE (V)	CURRENT (A)	W/O INDICATION		WITH INDICATION		PKG
			CAT. NUMBER	REF. NUMBER	CAT. NUMBER	REF. NUMBER	
1	400VAC	2	09490.021100	N1004376	09490.021000	D1004390	12
1	400VAC	4	09490.041100	P1004377	09490.041000	E1004391	12
1	400VAC	6	09490.061100	Q1004378	09490.061000	F1004392	12
2	400VAC	6	09490.062100	R1004379	09490.062000	G1004393	6
3	400VAC	6	09490.063100	S1004380	09490.063000	J1004395	4
1	400VAC	10	09490.101100	T1004381	09490.101000	K1004396	12
2	400VAC	10	09490.102100	V1004382	09490.102000	L1004397	6
3	400VAC	10	09490.103100	W1004383	09490.103000	M1004398	4
1	400VAC	13	09490.131100	X1004384	09490.131000	P1004400	12
2	400VAC	13	09490.132100	Y1004385	09490.132000	Q1004401	6
3	400VAC	13	09490.133100	Z1004386	09490.133000	R1004402	4
1	400VAC	16	09490.161100	A1004387	09490.161000	S1004403	12
2	400VAC	16	09490.162100	B1004388	09490.162000	T1004404	6
3	400VAC	16	09490.163100	C1004389	09490.163000	W1004406	4



Innozed - D01

16 A, 400VAC, 1 pole E14

CAT. NUMBER	REF. NUMBER	DESIGN	PKG
04724.000000	W1032489	both sides double function clamp 1.5-35 mm²	9



16 A, 400VAC, 3 poles E14

CAT. NUMBER	REF. NUMBER	DESIGN	PKG
04734.000000	X1032490	both sides double function clamp 1.5-35 mm²	3

LOW VOLTAGE D0 FUSES

Fusegear - D01



ep.mersen.com



Neozed fuse bases w/o shock-proof protection-cover

NO. OF POLES	VOLTAGE (V)	CURRENT (A)	TERMINAL TYPE	FOR SNAP-ON FASTENING		FOR SCREW MOUNTING		PKG
				CAT. NUMBER	REF. NUMBER	CAT. NUMBER	REF. NUMBER	
1	400VAC	16	1	01720.150000	J200660	01720.100000	Z216061	20
1	400VAC	16	3	01730.152000	B216063	-	-	20
3	400VAC	16	1	-	-	01730.100000	K200661	5



Neozed fuse bases with shock-proof protection-cover

NO. OF POLES	VOLTAGE (V)	CURRENT (A)	TERMINAL TYPE	CAT. NUMBER	REF. NUMBER	PKG
1	400VAC	16	1	01720.170000	B211463	20
1	400VAC	16	3	01720.370000	T215550	20
3	400VAC	16	1	01730.172000	A219144	5

Terminal type

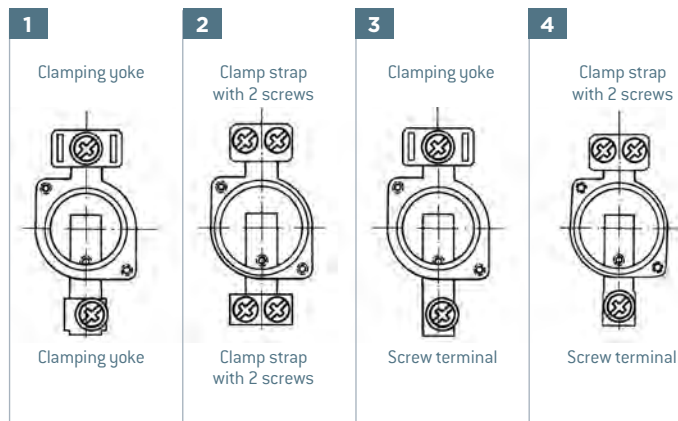

LOW VOLTAGE D0 FUSES

Neozed gG - D02



400 VAC - 250 VDC
Breaking capacity: 50 kA

CAT. NUMBER	REF. NUMBER	CURRENT (A)	COLOR CODE	PKG
D02GG40V20	B217742	20	blue	50
D02GG40V25	W213160	25	yellow	50
D02GG40V32	S227647	32	black	50
D02GG40V35	R219826	35	black	50
D02GG40V50	D215191	50	white	50
D02GG40V63	C201873	63	copper	50



ep.mersen.com

Neozed aM - D02



440 VAC
Breaking capacity: 50 kA

CAT. NUMBER	REF. NUMBER	CURRENT (A)	COLOR CODE	PKG
D02AM44V20	H211607	20	blue	10
D02AM44V25	F212640	25	yellow	10
D02AM44V35	J213655	35	black	10

Fusegear - D02



D0 Linocur® D02 230/400VAC, 65VDC

CAT. NUMBER	REF. NUMBER	CURRENT (A)	WIDTH	NO. OF POLES	CROSS SECTION	WEIGHT	PKG
05861.063000	Z1012620	63 A	27 mm	1	35 mm ²	138 g	3
05862.063000	J1012606	63 A	54 mm	2	35 mm ²	279 g	2
05863.063000	B1012622	63 A	81 mm	3	35 mm ²	418 g	1
05861.063100	H1012628	63 A	54 mm	1+N	35 mm ²	253 g	2
05863.063100	E1012602	63 A	108 mm	3+N	35 mm ²	531 g	1

D0 Linocur® D02 220VDC

CAT. NUMBER	REF. NUMBER	CURRENT (A)	WIDTH	NO. OF POLES	CROSS SECTION	WEIGHT	PKG
05864.063000	L1012608	63 A	108 mm	4	35 mm ²	554 g	1



D0 Linocur® D02 230VAC to 400VAC, 65VDC, fuse-links and gauge pieces

CAT. NUMBER	REF. NUMBER	CURRENT (A)	WIDTH	NO. OF POLES	CROSS SECTION	WEIGHT	PKG
05863.025000	G1012627	25 A	81 mm	3	35 mm ²	457 g	2
05863.035000	E1012625	35 A	81 mm	3	35 mm ²	475 g	1
05863.050000	P1012611	50 A	81 mm	3	35 mm ²	462 g	1

LOW VOLTAGE D0 FUSES

Fusegear - D02



Innozed - D02



63 A, 400VAC, 1 pole E18

CAT. NUMBER	REF. NUMBER	DESIGN	PKG
04725.000000	Y1032491	both sides double function clamp 1.5-35 mm ²	9

63 A, 400VAC, 3 poles E18

CAT. NUMBER	REF. NUMBER	DESIGN	PKG
04735.000000	Z1032492	both sides double function clamp 1.5-35 mm ²	3



Neozed fuse bases w/o shock-proof protection-cover

NO. OF POLES	VOLTAGE (V)	CURRENT (A)	TERMINAL TYPE	FOR SNAP-ON FASTENING		FOR SCREW MOUNTING		PKG
				CAT. NUMBER	REF. NUMBER	CAT. NUMBER	REF. NUMBER	
1	400VAC	63	2	01721.250000	J218623	01721.200000	M214532	20
1	400VAC	63	4	01721.450000	W215552	01721.400000	F213008	20
3	400VAC	63	2	01731.252000	Y217601	01731.200000	F216573	5



Neozed fuse bases with shock-proof protection-cover

NO. OF POLES	VOLTAGE (V)	CURRENT (A)	TERMINAL TYPE	CAT. NUMBER	REF. NUMBER	PKG
1	400VAC	63	2	01721.270000	M200663	20
1	400VAC	63	4	01721.470000	K218624	20
3	400VAC	63	2	01731.272000	E222874	5
3	400VAC	63	4	01731.472000	K213518	5

Terminal type

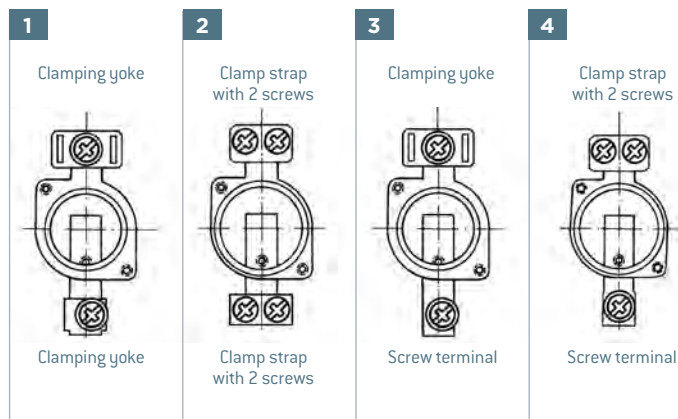

LOW VOLTAGE D0 FUSES

Neozed gG - D03



400 VAC - 250 VDC
Breaking capacity: 50 kA

CAT. NUMBER	REF. NUMBER	CURRENT (A)	COLOR CODE	PKG
D03GG40V80	L216716	80	silver	10
D03GG40V100	N212647	100	red	10



Fusegear - D03



Neozed fuse bases w/o shock-proof protection-cover

NO. OF POLES	VOLTAGE (V)	CURRENT (A)	TERMINAL TYPE	FOR SNAP-ON FASTENING		FOR SCREW MOUNTING		PKG
				CAT. NUMBER	REF. NUMBER	CAT. NUMBER	REF. NUMBER	
1	400VAC	100	4	01722.450000	Q214535	01722.400000	J213011	10



Neozed fuse bases with shock-proof protection-cover

NO. OF POLES	VOLTAGE (V)	CURRENT (A)	TERMINAL TYPE	CAT. NUMBER	REF. NUMBER	PKG
1	400VAC	100	4	01722.470000	F216067	10

Terminal type

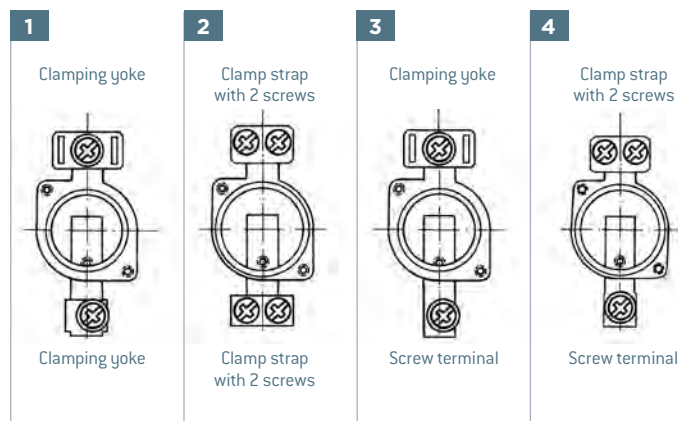

LOW VOLTAGE D0 FUSES

Accessories



Neozed Screw caps porcelain

SIZE	VOLTAGE (V)	CURRENT (A)	CAP THREAD	CAT. NUMBER	REF. NUMBER	PKG
with testing hole						
D01	440VAC	16	E 14	01710.000200	H201211	20
D02	440VAC	63	E 18	01711.000200	T215044	20
D03	440VAC	100	M30x2	01712.000200	V215045	10



Neozed Screw caps plastic

SIZE	VOLTAGE (V)	CURRENT (A)	CAP THREAD	CAT. NUMBER	REF. NUMBER	PKG
with testing hole						
D01	400VAC	16	E 14	01714.000200	E212501	20
D02	400VAC	63	E 18	01715.000200	P211981	20
with sealable hole & testing hole						
D01	400VAC	16	E 14	11714.000220	R214536	20
D02	400VAC	63	E 18	11715.000220	S214537	20

Insulated wiring bars

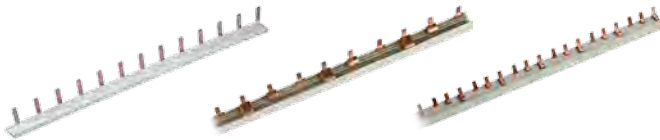

CAT. NUMBER	REF. NUMBER	DESIGN	WEIGHT	PKG
02963.000000	M215107	single pole, 16 mm ² , partition 27 mm (distance of poles), peg Design, L-shaped	190 g	50
22963.003000	K302873	triple pole, 16 mm ² , partition 27 mm (distance of poles), peg Design, L-shaped	590 g	10
22963.363000	L302874	triple pole, 35 mm ² , partition 27 mm (distance of poles), peg Design, L-shaped	590 g	10
02901.000000	E302891	end cap for single pole wiring bus bar	1 g	10
02903.165000	G302893	end cap for triple pole wiring bus bars up to 16 mm ²	1 g	10
02903.350000	R302902	end cap for triple pole wiring bus bars up to 35 mm ²	1 g	10

Neozed space holder insert



SIZE	CAT. NUMBER	REF. NUMBER	PKG
for D02 fuse-links in D03-socket			
D02->D03	01707.000000	T211985	30



Neozed Gauge rings



ep.mersen.com

SIZE	CURRENT (A)	COLOR CODE	CAT. NUMBER	REF. NUMBER	PKG
D01	2	pink	01705.002000	J216576	50
D01	4	brown	01705.004000	J219681	50
D01	6	green	01705.006000	P206438	50
D01	10	red	01705.010000	M213014	50
D02	2	pink	01706.002000	K216577	50
D02	4	brown	01706.004000	S222127	50
D02	6	green	01706.006000	R211983	50
D02	10	red	01706.010000	H216069	50
D02	16	grey	01706.016000	Q218629	50
D02	20	blue	01706.020000	S200668	50
D02	25	yellow	01706.025000	R213524	50
D02	35	black	01706.035000	J216070	50
D02	50	white	01706.050000	R218630	50
D03	80	silver	01707.080000	T200669	20



Neozed Special holding springs

SIZE	VOLTAGE (V)	CAT. NUMBER	REF. NUMBER	PKG
D01 fuse-links in DL-socket				
D01->DL	400VAC	01733.000000	J218117	100
D01 fuse-links in D02-socket				
D01->D02	400VAC	01713.000000	Z215049	50
D02 fuse-links in D03-socket				
D02->D03	400VAC	01709.000000	P214028	25



Communication

CAT. NUMBER	REF. NUMBER	DESIGN	WEIGHT	PKG
05860.200000	H1015204	Monitoring Device, for fuse operation type 2, cross section 1,5mm ²	-	1
05860.300000	J1015205	Monitoring Device, for switch position and fuseoperation type 3, cross section 1,5mm ²	-	1

BS88 FUSES AND FUSEGEAR OFFERING

BS88 fuses

	FUSES		
	VOLTAGE	RATING	TYPE
Offset Bolted Tag Fuse Links 	400VAC 240VDC	36 - 200M315	Type A
Central Bolted Tag Fuse Links 	415VAC 240VDC	32 - 800	Type B & C
Offset Blade/Offset Tag Fuse Links 	550VAC 250VDC	2 - 32M63	Type F & A
Offset Bolted Tag Fuse Links 	690VAC 460VDC	2 - 80M100	Type A
Central Bolted Tag Fuse Links 	690VAC 460VDC	80 - 800	Type B & C

Fusegear

FUSE HOLDERS	PAGES
	44
<p>BFF Front wire connected</p>	45
	46
<p>BBB Back stud connected</p>	47
	48

Offset Bolted Tag Fuse Links (A-type)



415 VAC Breaking Capacity: 80 kA
240/250 VDC Breaking Capacity: 40 kA

VOLTAGE (V) BS TYPE REF	RATING (A)	REFERENCE NUMBER	CATALOGUE NUMBER	BS TYPE REF	STD. PACK
415VAC 240VDC	36	M1045269J	BTIS42V36	A3	10
	40	N1045270J	BTIS42V40	A3	10
	50	P1045271J	BTIS42V50	A3	10
	63	Q1045272J	BTIS42V63	A3	10
	80	R1045273J	BTIS42V80	A3	10
	100	S1045274J	BTIS42V100	A3	10
415VAC 240VDC	125	L1019186J	BTIS42V125	A3	10
	160	M1019187J	BTIS42V160	A3	10
	100M125	N1019188J	BTIS42V100M125	A3	10
	100M160	Q1019190J	BTIS42V100M160	A3	10
415VAC 240VDC	36	T1045275J	BTCP42V36	A4C	10
	40	Z1045280J	BTCP42V40	A4C	10
	50	S1045297J	BTCP42V50	A4C	10
	63	T1045298J	BTCP42V63	A4C	10
	80	V1045299J	BTCP42V80	A4C	10
	100	X1045301J	BTCP42V100	A4C	10
415VAC 240VDC	125	W1019195J	BTCP42V125	A4	10
	160	X1019196J	BTCP42V160	A4	10
	100M125	A226297J	BTCP42V100M125	A4C	10
	100M160	B226298J	BTCP42V100M160	A4C	10
	100M200	C226299E	BTCP42V100M200	A4C	5
415VAC 240VDC	125	D226300E	BTFP42V125	A4XC	5
	160	E226301E	BTFP42V160	A4XC	5
	200	F226302E	BTFP42V200	A4XC	5
	200M250	G226303E	BTFP42V200M250	A4X	5
	200M315	H226304E	BTFP42V200M315	A4X	5

BS88 FUSES

Central Bolted Tag Fuse Links (B & C-type)



ep.mersen.com



415 VAC Breaking Capacity: 80 kA
240 VDC Breaking Capacity: 40 kA

VOLTAGE (V)	RATING (A)	REFERENCE NUMBER	CATALOGUE NUMBER	BS TYPE REF	STD. PACK
415VAC 240VDC	32	J226305J	BTBC42V32	B1C	10
	40	K226306J	BTBC42V40	B1C	10
	50	L226307J	BTBC42V50	B1C	10
	63	M226308J	BTBC42V63	B1C	10
415VAC 240VDC	80	Y1045302J	BTC42V80	B1C	10
	100	Z1045303J	BTC42V100	B1C	10
415VAC 240VDC	125	E1019203J	BTC42V125	B1	10
	160	F1019204J	BTC42V160	B1	10
	100M125	Q226311J	BTC42V100M125	B1C	10
	100M160	R226312J	BTC42V100M160	B1C	10
	100M200	S226313E	BTC42V100M200	B1C	5
415VAC 240VDC	125	T226314E	BTF42V125	B2C	5
	160	V226315E	BTF42V160	B2C	5
	200	W226316E	BTF42V200	B2C	5
	200M250	X226317A	BTF42V200M250	B2	1
	200M315	Y226318A	BTF42V200M315	B2	1
415VAC 240VDC	250	Z226319A	BTKF42V250	B3	1
	315	A226320A	BTKF42V315	B3	1
	315M400	B226321A	BTKF42V315M400	B3	1
415VAC 240VDC	250	C226322A	BTKM42V250	B3X	1
	315	D226323A	BTKM42V315	B3X	1
415VAC 240VDC	355	E226324A	BTMF42V355	B4	1
	400	F226325A	BTMF42V400	B4	1
415VAC 240VDC	355	G226326A	BTM42V355	C1	1
	400	H226327A	BTM42V400	C1	1
415VAC 240VDC	450	J226328A	BTTM42V450	C2	1
	500	K226329A	BTTM42V500	C2	1
	560	L226330A	BTTM42V560	C2	1
	630	M226331A	BTTM42V630	C2	1
415VAC 240VDC	670	N226332A	BTLM42V670	C3	1
	710	P226333A	BTLM42V710	C3	1
	750	Q226334A	BTLM42V750	C3	1
	800	R226335A	BTLM42V800	C3	1

BS88 FUSES

Offset Blade/Offset Tag Fuse Links (F & A-type)



415/550 VAC Breaking Capacity: 80 kA
250 VDC Breaking Capacity: 40 kA

VOLTAGE (V)	RATING (A)	REFERENCE NO.	CATALOGUE NO.	BS TYPE REF	STD. PACK
550VAC 250VDC	2	C1006643J	BNS55V2	F1	10
	4	D1006644J	BNS55V4	F1	10
	6	E1006645J	BNS55V6	F1	10
	10	N1019211J	BNS55V10	F1	10
	16	P1019212J	BNS55V16	F1	10
	20	Q1019213J	BNS55V20	F1	10
	25	R1019214J	BNS55V25	F1	10
	32	S1019215J	BNS55V32	F1	10
	10M16	T1019216J	BS55V10M16	F1	10
	16M20	V1019217J	BNS55V16M20	F1	10
	20M25	W1019218J	BNS55V20M25	F1	10
	20M32	X1019219J	BNS55V20M32	F1	10
	25M32	Z1019221J	BNS55V25M32	F1	10
550VAC	2	Y1050799J	BES55V2*	F2	10
	4	Z1050800J	BES55V4*	F2	10
	6	A1050801J	BES55V6*	F2	10
	10	F1006646J	BES55V10	F2	10
	16	G1006647J	BES55V16	F2	10
	20	H1006648J	BES55V20	F2	10
	25	J1006649J	BES55V25	F2	10
	32	K1006650J	BES55V32	F2	10
415VAC	40	J226351J	BES42V40	F2	10
	50	K226352J	BES42V50	F2	10
	63	L226353J	BES42V63	F2	10
550VAC 250VDC	2	E1006576J	BNIT55V2	A1	10
	4	F1006577J	BNIT55V4	A1	10
	6	G1006578J	BNIT55V6	A1	10
	10	B1019223J	BNIT55V10	A1	10
	16	C1019224J	BNIT55V16	A1	10
	20	D1019225J	BNIT55V20	A1	10
	25	E1019226J	BNIT55V25	A1	10
	32	F1019227J	BNIT55V32	A1	10
	10M16	G1019228J	BNIT55V10M16	A1	10
	16M20	H1019229J	BNIT55V16M20	A1	10
	20M25	J1019230J	BNIT55V20M25	A1	10
	20M32	K1019231J	BNIT55V20M32	A1	10
	25M32	R1019237J	BNIT55V25M32	A1	10
550VAC 250VDC	2	S1019238J	BTIA55V2	A2C	10
	4	T1019239J	BTIA55V4	A2C	10
	6	V1019240J	BTIA55V6	A2C	10
	10	W1019241J	BTIA55V10	A2C	10
	16	X1019242J	BTIA55V16	A2C	10
	20	Y1019243J	BTIA55V20	A2C	10
	25	Z1019244J	BTIA55V25	A2C	10
	32	A1019245J	BTIA55V32	A2C	10
	10M16	B1019246J	BTIA55V10M16	A2C	10
	16M20	C1019247J	BTIA55V16M20	A2C	10
	20M25	D1019248J	BTIA55V20M25	A2C	10
	20M32	E1019249J	BTIA55V20M32	A2C	10
	25M32	F1019250J	BTIA55V25M32	A2C	10
415VAC 250VDC	32M40	G226280J	BTIA42V32M40	A2	10
	32M50	H226251J	BTIA42V32M50	A2	10
	32M63	K226383J	BTIA42V32M63	A2	10

Note that items marked with an * are not ASTA Certified

BS88 FUSES

Offset Bolted Tag Fuse Links (A-type)



ep.mersen.com

690 VAC Breaking Capacity: 80 kA
460 VDC Breaking Capacity: 40 kA

VOLTAGE (V)	RATING (A)	REFERENCE NUMBER	CATALOGUE NUMBER	BS TYPE REF	STD. PACK
690VAC 460VDC	2	G1019251J	BTIA69V2	A2	10
	4	H1019252J	BTIA69V4	A2	10
	6	J1019253J	BTIA69V6	A2	10
	10	K1019254J	BTIA69V10	A2	10
	16	L1019255J	BTIA69V16	A2	10
	20	M1019256J	BTIA69V20	A2	10
	25	N1019257J	BTIA69V25	A2	10
	32	P1019258J	BTIA69V32	A2	10
	10M16	A1019751J	BTIA69V10M16	A2	10
	16M20	B1019752J	BTIA69V16M20	A2	10
	20M25	Q1019259J	BTIA69V20M25	A2	10
	20M32	R1019260J	BTIA69V20M32	A2	10
	25M32	C1019753J	BTIA69V25M32	A2	10
	36	S1019261J	BTIA69V36	A2	10
	40	T1019262J	BTIA69V40	A2	10
	50	V1019263J	BTIA69V50	A2	10
	63	W1019264J	BTIA69V63	A2	10
	32M36	A1019268J	BTIA69V32M36	A2	10
	32M40	X1019265J	BTIA69V32M40	A2	10
32M50	Y1019266J	BTIA69V32M50	A2	10	
32M63	Z1019267J	BTIA69V32M63	A2	10	
690VAC 460VDC	36	N1006584J	BTIS69V36	A3	10
	40	P1006585J	BTIS69V40	A3	10
	50	Q1006586J	BTIS69V50	A3	10
	63	R1006587J	BTIS69V63	A3	10
	32M36	C1019270J	BTIS69V32M36	A3	10
	32M40	D1006598J	BTIS69V32M40	A3	10
	32M50	E1006599J	BTIS69V32M50	A3	10
	32M63	F1006600J	BTIS69V32M63	A3	10
690VAC 460VDC	36	H1019275J	BTCP69V36	A4C	10
	40	M1006606J	BTCP69V40	A4C	10
	50	N1006607J	BTCP69V50	A4C	10
	63	J1019276J	BTCP69V63	A4C	10
	32M36	K1019277J	BTCP69V32M36	A4C	10
	32M40	L1019278J	BTCP69V32M40	A4C	10
	32M50	M1019279J	BTCP69V32M50	A4C	10
	32M63	N1019280J	BTCP69V32M63	A4C	10
	80	S1006611J	BTCP69V80	A4	10
	100	T1006612J	BTCP69V100	A4	10
	63M80	V1006613J	BTCP69V63M80	A4	10
	63M100	W1006614J	BTCP69V63M100	A4	10
	80M100	Z1054365J	BTCP69V80M100*	A4	10

Note that items marked with an * are not ASTA Certified

BS88 FUSES

Central Bolted Tag Fuse Links (B & C-type)



690 VAC Breaking Capacity: 80 kA
460 VDC Breaking Capacity: 40 kA

VOLTAGE (V)	RATING (A)	REFERENCE NUMBER	CATALOGUE NUMBER	BS TYPE REF	STD. PACK
690VAC 460VDC	80	B1019775J	BTC69V80	B1	10
	100	A1006618J	BTC69V100	B1	10
	63M80	B1006619J	BTC69V63M80	B1	10
	63M100	C1006620J	BTC69V63M100	B1	10
	80M100	A1054366J	BTC69V80M100*	B1	10
690VAC 460VDC	125	D1006621E	BTF69V125	B2	5
	160	E1006622E	BTF69V160	B2	5
	200	F1006623E	BTF69V200	B2	5
	125M160	G1006624E	BTF69V125M160	B2	5
	125M200	H1006625E	BTF69V125M200	B2	5
690VAC 460VDC	250	P1036991A	BTKF69V250	B3	1
	315	Q1036992A	BTKF69V315	B3	1
690VAC 460VDC	250	J1006626A	BTMF69V250	B4	1
	315	K1006627A	BTMF69V315	B4	1
	355	L1006628A	BTMF69V355	B4	1
	400	M1006629A	BTMF69V400	B4	1
	315M400	N1006630A	BTMF69V315M400	B4	1
690VAC 460VDC	250	P1006631A	BTM69V250	C1	1
	315	R1006633A	BTM69V315	C1	1
	355	S1006634A	BTM69V355	C1	1
	400	W1006637A	BTM69V400	C1	1
690VAC	450	Y1006639A	BTTM69V450	C2	1
	500	Z1006640A	BTTM69V500	C2	1
	560	A1006641A	BTTM69V560	C2	1
	630	B1006642A	BTTM69V630	C2	1
690VAC	670	D1019271A	BTLM69V670	C3	1
	710	E1019272A	BTLM69V710	C3	1
	750	F1019273A	BTLM69V750	C3	1
	800	G1019274A	BTLM69V800	C3	1

Note that items marked with an * are not ASTA Certified

BS88 FUSE HOLDERS

For Offset Blade & Bolted Tag Fuse Links



For Offset Blade & Bolted Tag Fuse Links

Fuse holders from Mersen comply with BS88-1 and BS88-6: 1988. The fuse holders are designed to prevent direct contact with live parts when being inserted or removed, preventing any likelihood of inadvertent contact with live metal. Also, cable terminals within the fuse base are fully shrouded when holder is removed (product is IP2X Classified).

Type Of Connection



BFF Front wire connected
(front-front) 3 connection styles possible: Mounting on board with cable upstream and downstream



BBB Back stud connected
(back-back) Mounting on board with two cables on the back (connection via lug. see table)



BFB Front Back (busbar) stud connected Mounting on board with upstream or downstream cable and back cable



Advantage

1. DIN Rail Mounting for ease of assembly
2. Safety Shrouds
3. Options for colour and terminations
4. RoHs compliance

BS88 FUSE HOLDERS

For Offset Blade & Bolted Tag Fuse Links



TYPE	VOLTAGE RATING (V)	NOMINAL CURRENT (A)	COLOR	CONNECTION	REFERENCE NUMBER	CATALOGUE NUMBER	STANDARD PACK	MERSEN USE/NEUTRAL LINK TYPE
F1	550	32	Black	Front-Front	A230138F	BFF32F1	6	BNS55Vxx
F1	550	32	Black	Back-Back	N239120F	BBB32F1	6	
F1	550	32	Black	Front-Back	B230139F	BFB32F1	6	
F1	550	32	Green	Front-Front	B1012553F	BFF32F1G	6	
F1	550	32	Green	Back-Back	V1012547F	BBB32F1G	6	
F1	550	32	Green	Front-Back	Y1012550F	BFB32F1G	6	
F1	550	32	White	Front-Front	P239121F	BFF32F1W	6	BNEUTRALF1
F1	550	32	White	Back-Back	Q239122F	BBB32F1W	6	
F1	550	32	White	Front-Back	R239123F	BFB32F1W	6	
F1	550	32	-	-	D239134J	BNEUTRALF1	10	-
F2	550	63	Black	Front-Front	S239124F	BFF63F2	6	BES55Vxx BES42Vxx
F2	550	63	Black	Back-Back	T239125F	BBB63F2	6	
F2	550	63	Black	Front-Back	V239126F	BFB63F2	6	
F2	550	63	Green	Front-Front	Z239130F	BFF63F2G	6	
F2	550	63	Green	Back-Back	A239131F	BBB63F2G	6	
F2	550	63	Green	Front-Back	B239132F	BFB63F2G	6	
F2	550	63	White	Front-Front	W239127F	BFF63F2W	6	BNEUTRALF2
F2	550	63	White	Back-Back	X239128F	BBB63F2W	6	
F2	550	63	White	Front-Back	Y239129F	BFB63F2W	6	
F2	550	63	-	-	E239135J	BNEUTRALF2	10	-
A1	550	32	Black	Front-Front	D239088F	BFF32A1	6	BNIT55Vxx
A1	550	32	Black	Back-Back	E239089F	BBB32A1	6	
A1	550	32	Black	Front-Back	F239090F	BFB32A1	6	
A1	550	32	Green	Front-Front	K239094F	BFF32A1G	6	
A1	550	32	Green	Back-Back	L239095F	BBB32A1G	6	
A1	550	32	Green	Front-Back	M239096F	BFB32A1G	6	
A1	550	32	White	Front-Front	G239091F	BFF32A1W	6	BNEUTRALA1
A1	550	32	White	Back-Back	H239092F	BBB32A1W	6	
A1	550	32	White	Front-Back	J239093F	BFB32A1W	6	
A1	550	32	-	-	F239136J	BNEUTRALA1	10	-









ep.mersen.com

TYPE	VOLTAGE RATING (V)	NOMINAL CURRENT (A)	COLOR	CONNECTION	REFERENCE NUMBER	CATALOGUE NUMBER	STANDARD PACK	MERSEN USE/NEUTRAL LINK TYPE
A2	690	32	Black	Front-Front	C230140F	BFF32A2	6	BTIA55Vxx BTIA69Vxx
A2	690	32	Black	Back-Back	P1012542F	BBB32A2	6	
A2	690	32	Black	Front-Back	D230141F	BFB32A2	6	
A2	690	32	Green	Front-Front	Z1012551F	BFF32A2G	6	
A2	690	32	Green	Back-Back	S1012545F	BBB32A2G	6	
A2	690	32	Green	Front-Back	W1012548F	BFB32A2G	6	
A2	690	32	White	Front-Front	A1012552F	BFF32A2W	6	BNEUTRALA2
A2	690	32	White	Back-Back	T1012546F	BBB32A2W	6	
A2	690	32	White	Front-Back	X1012549F	BFB32A2W	6	
A2	690	32	-	-	G239137J	BNEUTRALA2	10	-
A3	690	63	Black	Front-Front	F230143F	BFF63A3	6	BTSS42Vxx BTS42Vxx BTS42Vxxx BTIS69Vxx
A3	690	63	Black	Back-Back	V239103F	BBB63A3	6	
A3	690	63	Black	Front-Back	G230144F	BFB63A3	6	
A3	690	63	Green	Front-Front	Z239107F	BFF63A3G	6	
A3	690	63	Green	Back-Back	A239108F	BBB63A3G	6	
A3	690	63	Green	Front-Back	B239109F	BFB63A3G	6	
A3	690	63	White	Front-Front	W239104F	BFF63A3W	6	BNEUTRALA3
A3	690	63	White	Back-Back	X239105F	BBB63A3W	6	
A3	690	63	White	Front-Back	Y239106F	BFB63A3W	6	
A3	690	63	-	-	H239138J	BNEUTRALA3	10	-
A4	690	125	Black	Front-Front	H230145A	BFF125A4	1	BTSD42Vxxx BTCP42Vxxx BTCP69Vxxx
A4	690	125	Black	Back-Back	C239110A	BBB125A4	1	
A4	690	125	Black	Front-Back	J230146A	BFB125A4	1	
A4	690	125	Green	Front-Front	K239117A	BFF125A4G	1	
A4	690	125	Green	Back-Back	L239118A	BBB125A4G	1	
A4	690	125	Green	Front-Back	M239119A	BFB125A4G	1	
A4	690	125	White	Front-Front	D239111A	BFF125A4W	1	BNEUTRALA4
A4	690	125	White	Back-Back	E239112A	BBB125A4W	1	
A4	690	125	White	Front-Back	F239113A	BFB125A4W	1	
A4	690	125	-	-	J239139J	BNEUTRALA4	10	-

SURGE-TRAP® RANGE OVERVIEW

**NEW
LINE**

		LOCATION	SPD TYPE	IIMP (10/350µS)	IMAX (8/20 µS)	IN (8/20 MS)	UOC (1,2/50µS)
 <p>STM T1</p> <p>FIRST STEP OF PROTECTION SOKA</p>		First step of protection	Type 1 lightning current arrester to IEC/EN 61643	50 kA (phase) / 100 kA (N-PE)	–	50 kA (phase) / 100 kA (N-PE)	–
 <p>STPT12</p> <p>COMBINED TYPE 1+2</p>		First step of protection	Type 1+2 SPD to IEC/EN 61643	12,5 kA	50 kA	20 kA	–
 <p>STPT2</p> <p>WIDE RANGE</p>		Second step of protection	Type 2 SPD to IEC/EN 61643	–	40 kA	20 kA	–
 <p>STPT2 PV</p> <p>PV EN50539-11 UL 1449</p>		For DC photovoltaic applications	Type 2 DC to EN-50539-11 UTE C 61740-51 UL 1449 3rd Ed. recognised	–	40 kA	20 kA	–
 <p>STPT23</p> <p>FINE PROTECTION</p>		Final stage of protection (very fine)	Type 2+3 SPD to IEC/EN 61643	–	20 kA	10 kA	10 kV
 <p>STM T23 SLIM</p> <p>SLIM: SPACE SAVING</p>		Final stage of protection (very fine)	Type 2+3 SPD to IEC/EN 61643	–	20 kA 10 kA 6 kA	10 kA 5 kA 3 kA	10 kV 6 kV
 <p>STE T23 EMI</p> <p>POWERFUL EMI FILTER</p>		Final stage of protection (very fine)	Type 2+3 SPD to IEC/EN 61643	–	20 kA	10 kA	6 kV

SPECIAL FEATURES	SUPPLY VOLTAGE UN (L-N/L-L)	NETWORK CONFIGURATION		FORMAT	TYPE ACCORDING TO EN 61643-11	PAGES
I_{fi} = 50kA follow current interrupt rating. Multi-sparkgap technology. Leakage current free.	120/208 V 230/400 V 277/480 V 400/690 V	TNS, TNC, TT, IT	Single phase Split phase 3-phase WYE; Delta	DIN-rail mountable. Monobloc format	Type 1	54
ELV: Extra Low Voltage models available. Reversible & coded cartridges.	60 V 120/208 V 230/400 V 277/480 V 400/690 V	TNS, TNC, TT, IT	Single phase Split phase 3-phase WYE; Delta	DIN-rail mountable. Pluggable format	Type 1+2	54
ELV: Extra Low Voltage models available. Reversible & coded cartridges.	48 V, 60 V 120/208 V 230/400 V 277/480 V 400/690 V + above	TNS, TNC, TT, IT	Single phase Split phase 3-phase WYE; Delta	DIN-rail mountable. Pluggable format	Type 2	55-56
I_{scpv} = 10kA (no back-up fuse needed). SCCR 100kA and 50kA. Reversible & coded cartridges.	65 VDC 80 VDC 660 VDC 1060 VDC 1500 VDC	PV (DC side)	–	DIN-rail mountable. Pluggable format	Type 3	57-59
PLC: Power Line Communication friendly solutions (LCF). Reversible & coded cartridge.	120/208 V 230/400 V 277/480 V 400 V	TNS, TNC, IT, TT	Single phase Split phase 3-phase WYE; Delta	DIN-rail mountable. Pluggable format	Type 2+3	59
Ideal for limited spaces (1 module).	12 V, 24 V 48 V, 60 V 120 V, 230 V Also for use in DC voltage applications	Single Phase TT, TNS	–	DIN-rail mountable. Monobloc format	Type 2+3	62
Filter attenuation up to 82dB (common mode) vs electromagnetic disturbances. Rated current load up to 20A.	120 V, 230 V	Single Phase TT, TNS	–	DIN-rail mountable. Monobloc format	Type 2+3	62

Surge-Trap® Type 1 SPDs STM T1 50



ep.mersen.com



1 pole

REF. NUMBER	CAT. NUMBER	Network		UN [VAC]	UC [V]	IIMP (10/350) [kA]	IN (8/20) [kA]	UP@IN (8/20) [kV]
		SYSTEM TYPE	ELECTRICAL DIAGRAM					
83010103	STMT1-50K150V-1P	L-N (1Ph)	A	120	150	50	50	≤2
83010100	STMT1-50K275V-1P	L-N (1Ph)	A	230	275	50	50	≤2
83010104	STMT1-50K320V-1P	L-N (1Ph)	A	277	320	50	50	≤2
83010107	STMT1-50K440V-1P	L-N (1Ph)	A	400	440	50	50	≤2,5
83010102	STMT1-100K-N	N-PE (N)	B	Neutral	255	100	100	≤2

Approvals/ Standards

- EN/CEI 61643-11
- CE

Dimensions

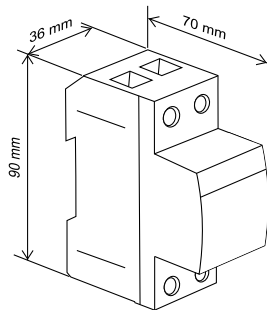

Electrical diagrams

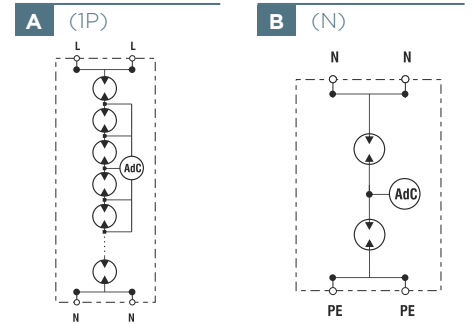

Surge-Trap® Type 1+2 SPDs STM T12 12.5



1 pole

REF. NUMBER	CAT. NUMBER	Network		UN [VAC]	UC [V]	IIMP (10/350) [kA]	IMAX (8/20) [kA]	IN (8/20) [kA]	UP@IN (8/20) [kV]	REMOTE (M)	Cartridge Id.	
		SYSTEM TYPE	ELECTRICAL DIAGRAM								L	N
83120100	STPT12-12K150V-1P	L-N (1Ph)	A	120	150	12,5	50	20	≤1		C02	-
83120101	STPT12-12K150V-1PM	L-N (1Ph)	A	120	150	12,5	50	20	≤1	√	C02	-
83120102	STPT12-12K275V-1P	L-N (1Ph)	A	230	275	12,5	50	20	≤1,3		C03	-
83120103	STPT12-12K275V-1PM	L-N (1Ph)	A	230	275	12,5	50	20	≤1,3	√	C03	-
83120104	STPT12-12K320V-1P	L-N (1Ph)	A	277	320	12,5	50	20	≤1,4		C04	-
83120105	STPT12-12K320V-1PM	L-N (1Ph)	A	277	320	12,5	50	20	≤1,4	√	C04	-
83120106	STPT12-12K440V-1P	L-N (1Ph)	A	400	440	12,5	50	20	≤1,8		C05	-
83120107	STPT12-12K440V-1PM	L-N (1Ph)	A	400	440	12,5	50	20	≤1,8	√	C05	-
83120108	STPT12-25K-N	N-PE (N)	B	Neutral	255	25	50	25	≤1,5		-	C06
83120110	STPT12-50K-N	N-PE (N)	B	Neutral	255	50	50	50	≤1,5		-	C07

Approvals/ Standards

- EN/CEI 61643-11
- CE

Dimensions

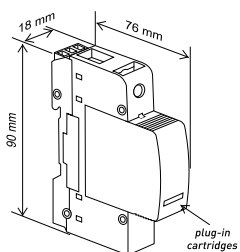

Microswitch diagram

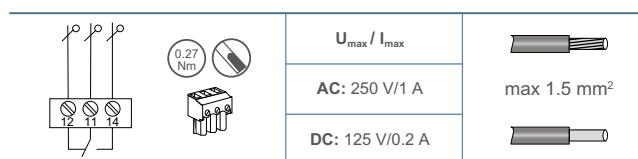

Electrical diagrams

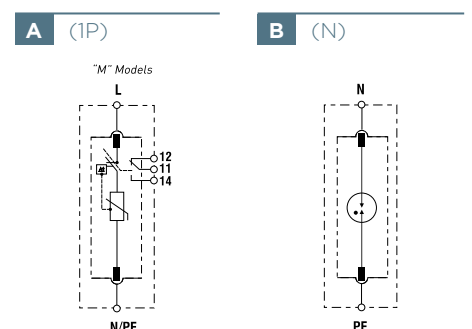

Surge-Trap® Type 1+2 SPDs STP T12 12.5



ep.mersen.com

Dimensions

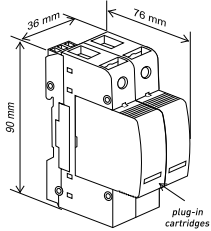

2 poles

REF. NUMBER	CAT. NUMBER	Network								Cartridge Id.		
		SYSTEM TYPE	ELECTRICAL DIAGRAM	UN [VAC]	UC [V]	IIMP (10/350) [KA]	IMAX (8/20) [KA]	IN (8/20) [KA]	UP@IN (8/20) [KV]	REMOTE (M)	L	N
83120126	STPT12-12K75V-2P	TNS (1Ph+N); PV	C	60/-	75;80 Ucpv	12,5	50	20	≤0,65		C01	
83120127	STPT12-12K75V-2PM	TNS (1Ph+N); PV	C	60/-	75;80 Ucpv	12,5	50	20	≤0,65	√	C01	
83120112	STPT12-12K150V-2PG	TT (1Ph+N)	D	120/-	150	12,5 (LN) 25 (N-PE)	50	20	≤1 (LN) ≤1,5 (N-PE)		C02	C06
83120113	STPT12-12K150V-2PGM	TT (1Ph+N)	D	120/-	150	12,5 (LN) 25 (N-PE)	50	20	≤1 (LN) ≤1,5 (N-PE)	√	C02	C06
83120114	STPT12-12K275V-2PG	TT (1Ph+N)	D	230/-	275	12,5 (LN) 25 (N-PE)	50	20	≤1,3 (LN) ≤1,5 (N-PE)		C03	C06
83120115	STPT12-12K275V-2PGM	TT (1Ph+N)	D	230/-	275	12,5 (LN) 25 (N-PE)	50	20	≤1,3 (LN) ≤1,5 (N-PE)	√	C03	C06
83120116	STPT12-12K320V-2PG	TT (1Ph+N)	D	277/-	320	12,5 (LN) 25 (N-PE)	50	20	≤1,4 (LN) ≤1,5 (N-PE)		C04	C06
83120117	STPT12-12K320V-2PGM	TT (1Ph+N)	D	277/-	320	12,5 (LN) 25 (N-PE)	50	20	≤1,4 (LN) ≤1,5 (N-PE)	√	C04	C06
83120118	STPT12-12K150V-2P	TNS (1Ph+N)	F	120/-	150	12,5	50	20	≤1		C02	
83120119	STPT12-12K150V-2PM	TNS (1Ph+N)	F	120/-	150	12,5	50	20	≤1	√	C02	
83120120	STPT12-12K275V-2P	TNS (1Ph+N)	F	230/-	275	12,5	50	20	≤1,3		C03	
83120121	STPT12-12K275V-2PM	TNS (1Ph+N)	F	230/-	275	12,5	50	20	≤1,3	√	C03	
83120122	STPT12-12K320V-2P	TNS (1Ph+N)	F	277/-	320	12,5	50	20	≤1,4		C04	
83120123	STPT12-12K320V-2PM	TNS (1Ph+N)	F	277/-	320	12,5	50	20	≤1,4	√	C04	
83120124	STPT12-12K440V-2P	IT (1Ph+N); TNS(1Ph+N)	C	230/-; 400/-	440	12,5	50	20	≤1,8		C05	
83120125	STPT12-12K440V-2PM	IT (1Ph+N); TNS(1Ph+N)	C	230/-; 400/-	440	12,5	50	20	≤1,8	√	C05	

ELV

ELV Extra Low Voltage, also for use in DC Photovoltaic self-consumption / off-grid applications.

Dimensions

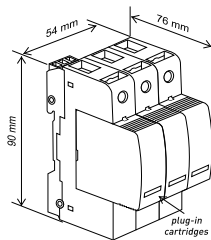

3 poles

REF. NUMBER	CAT. NUMBER	Network								Cartridge Id.		
		SYSTEM TYPE	ELECTRICAL DIAGRAM	UN [VAC]	UC [V]	IIMP (10/350) [KA]	IMAX (8/20) [KA]	IN (8/20) [KA]	UP@IN (8/20) [KV]	REMOTE (M)	L	N
83120128	STPT12-12K150V-3P	TNC (3Ph)	H	-/208	150	12,5	50	20	≤1		C02	-
83120129	STPT12-12K150V-3PM	TNC (3Ph)	H	-/208	150	12,5	50	20	≤1	√	C02	-
83120130	STPT12-12K275V-3P	TNC (3Ph)	H	-/400	275	12,5	50	20	≤1,3		C03	-
83120131	STPT12-12K275V-3PM	TNC (3Ph)	H	-/400	275	12,5	50	20	≤1,3	√	C03	-
83120132	STPT12-12K320V-3P	TNC (3Ph)	H	-/480	320	12,5	50	20	≤1,4		C04	-
83120133	STPT12-12K320V-3PM	TNC (3Ph)	H	-/480	320	12,5	50	20	≤1,4	√	C04	-
83120134	STPT12-12K440V-3P	IT (3Ph); TNC (3Ph)	I; H	-/400; -/690	440	12,5	50	20	≤1,8		C05	-
83120135	STPT12-12K440V-3PM	IT (3Ph); TNC (3Ph)	I; H	-/400; -/690	440	12,5	50	20	≤1,8	√	C05	-

Electrical diagrams

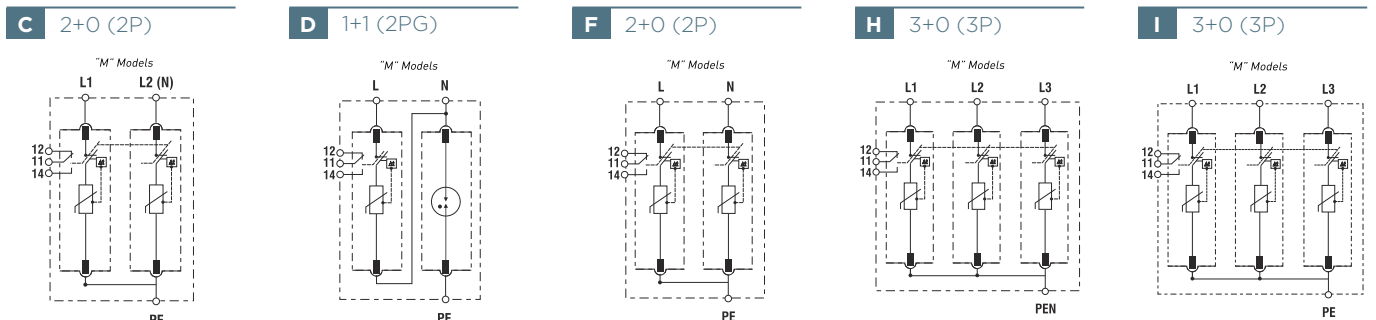

Surge-Trap® Type 1+2 SPDs STP T12 12.5



ep.mersen.com



Approvals/ Standards

- EN/CEI 61643-11
- CE

4 poles

REF. NUMBER	CAT. NUMBER	Network									Cartridge Id.	
		SYSTEM TYPE	ELECTRICAL DIAGRAM	UN [VAC]	UC [V]	IIMP (10/350) [KA]	IMAX (8/20) [KA]	IN (8/20) [KA]	UP@IN (8/20) [KV]	REMOTE (M)	L	N
83120136	STPT12-12K150V-4PG	TT (3Ph+N)	J	120/208	150	12,5 (L-N) 50 (N-PE)	50	20	≤1 (L-N) ≤1,5 (N-PE)		C02	C07
83120137	STPT12-12K150V-4PGM	TT (3Ph+N)	J	120/208	150	12,5 (L-N) 50 (N-PE)	50	20	≤1 (L-N) ≤1,5 (N-PE)	✓	C02	C07
83120138	STPT12-12K275V-4PG	TT (3Ph+N)	J	230/400	275	12,5 (L-N) 50 (N-PE)	50	20	≤1,3 (L-N) ≤1,5 (N-PE)		C03	C07
83120139	STPT12-12K275V-4PGM	TT (3Ph+N)	J	230/400	275	12,5 (L-N) 50 (N-PE)	50	20	≤1,3 (L-N) ≤1,5 (N-PE)	✓	C03	C07
83120140	STPT12-12K320V-4PG	TT (3Ph+N)	J	277/480	320	12,5 (L-N) 50 (N-PE)	50	20	≤1,4 (L-N) ≤1,5 (N-PE)		C04	C07
83120141	STPT12-12K320V-4PGM	TT (3Ph+N)	J	277/480	320	12,5 (L-N) 50 (N-PE)	50	20	≤1,4 (L-N) ≤1,5 (N-PE)	✓	C04	C07
83120142	STPT12-12K150V-4P	TNS (3Ph+N)	L	120/208	150	12,5	50	20	≤1		C02	
83120143	STPT12-12K150V-4PM	TNS (3Ph+N)	L	120/208	150	12,5	50	20	≤1	✓	C02	
83120144	STPT12-12K275V-4P	TNS (3Ph+N)	L	230/400	275	12,5	50	20	≤1,3		C03	
83120145	STPT12-12K275V-4PM	TNS (3Ph+N)	L	230/400	275	12,5	50	20	≤1,3	✓	C03	
83120146	STPT12-12K320V-4P	TNS (3Ph+N)	L	277/480	320	12,5	50	20	≤1,4		C04	
83120147	STPT12-12K320V-4PM	TNS (3Ph+N)	L	277/480	320	12,5	50	20	≤1,4	✓	C04	
83120148	STPT12-12K440V-4P	IT (3Ph+N); TNS (3Ph+N)	L	230/400; 400/690	440	12,5	50	20	≤1,8		C05	
83120149	STPT12-12K440V-4PM	IT (3Ph+N); TNS (3Ph+N)	L	230/400; 400/690	440	12,5	50	20	≤1,8	✓	C05	

Dimensions

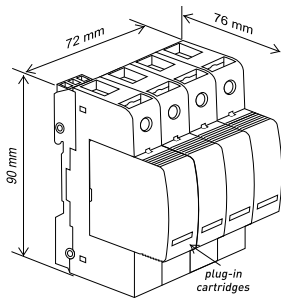

Electrical diagrams

J 3+1 (4PG)

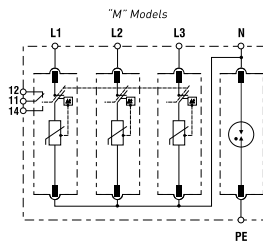

L 4+0 (4P)

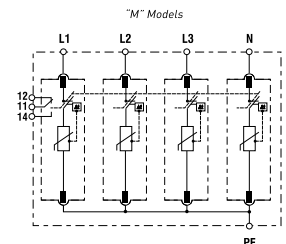

Replacement cartridges

REF. NUMBER	CAT. NUMBER	NETWORK	UN [VAC]	UC [V]	IIMP(10/350) [KA]	IMAX(8/20) [KA]	IN(8/20) [KA]	UP@IN(8/20) [KV]	CARTRIDGE ID.
83120000	SP12-12K75V	L-N (1Ph)	60	75	12,5	50	20	≤0,65	C01
83120001	SP12-12K150V	L-N (1Ph)	120	150	12,5	50	20	≤1	C02
83120002	SP12-12K275V	L-N (1Ph)	230	275	12,5	50	20	≤1,3	C03
83120003	SP12-12K320V	L-N (1Ph)	277	320	12,5	50	20	≤1,4	C04
83120004	SP12-12K440V	L-N (1Ph)	400	440	12,5	50	20	≤1,8	C05
83120005	SP12-25K-N	N-PE (N)	Neutral	255	25	50	25	≤1,5	C06
83120006	SP12-50K-N	N-PE (N)	Neutral	255	50	50	50	≤1,5	C07

Surge-Trap® Type 2 SPDs STP T2 40



ep.mersen.com



Dimensions

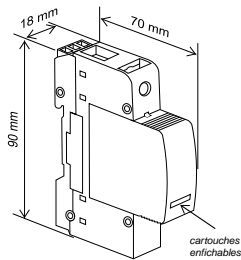

Dimensions

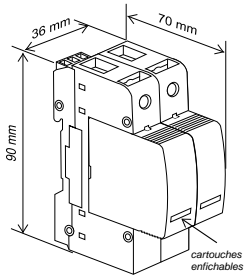

Approvals/ Standards

- EN/CEI 61643-11
- CE
- UL 1449 4th Edition recognized

1 pole

REF. NUMBER	CAT. NUMBER	Network								Cartridge Id.	
		SYSTEM TYPE	ELECTRICAL DIAGRAM	UN [VAC]	UC [V]	IMAX (8/20) [KA]	IN (8/20) [KA]	UP@IN (8/20) [KV]	REMOTE (M)	L	N
83020104	STPT2-40K150V-1P	L-N (1Ph)	A	120	150	40	20	≤0,9		C22	-
83020105	STPT2-40K150V-1PM	L-N (1Ph)	A	120	150	40	20	≤0,9	√	C22	-
83020106	STPT2-40K275V-1P	L-N (1Ph)	A	230	275	40	20	≤1,3		C23	-
83020107	STPT2-40K275V-1PM	L-N (1Ph)	A	230	275	40	20	≤1,3	√	C23	-
83020108	STPT2-40K320V-1P	L-N (1Ph)	A	277	320	40	20	≤1,4		C24	-
83020109	STPT2-40K320V-1PM	L-N (1Ph)	A	277	320	40	20	≤1,4	√	C24	-
83020110	STPT2-40K440V-1P	L-N (1Ph)	A	400	440	40	20	≤2		C25	-
83020111	STPT2-40K440V-1PM	L-N (1Ph)	A	400	440	40	20	≤2	√	C25	-
83020100	STPT2-30K750V-1P	L-N (1Ph)	A	690	750	30	15	≤3		C26	-
83020101	STPT2-30K750V-1PM	L-N (1Ph)	A	690	750	30	15	≤3	√	C26	-
83020112	STPT2-40K-N	N-PE (N)	B	Neutral	265	40	20	≤1,5		-	C27

2 poles

REF. NUMBER	CAT. NUMBER	Network								Cartridge Id.	
		SYSTEM TYPE	ELECTRICAL DIAGRAM	UN [VAC]	UC [V]	IMAX (8/20) [KA]	IN (8/20) [KA]	UP@IN (8/20) [KV]	REMOTE (M)	L	N
83020128	STPT2-40K60V-2P	TNS (1Ph+N); PV	C	48/-	60; 65 Ucpv	40	20	≤0,7		C20	
83020129	STPT2-40K60V-2PM	TNS (1Ph+N); PV	C	48/-	60; 65 Ucpv	40	20	≤0,7	√	C20	
83020130	STPT2-40K75V-2P	TNS (1Ph+N); PV	C	60/-	75; 80 Ucpv	40	20	≤0,8		C21	
83020131	STPT2-40K75V-2PM	TNS (1Ph+N); PV	C	60/-	75; 80 Ucpv	40	20	≤0,8	√	C21	
83020114	STPT2-40K150V-2PG	TT (1Ph+N)	D	120/-	150	40	20	≤0,9 (LN) ≤1,5 (N-PE)		C22	C27
83020115	STPT2-40K150V-2PGM	TT (1Ph+N)	D	120/-	150	40	20	≤0,9 (LN) ≤1,5 (N-PE)	√	C22	C27
83020116	STPT2-40K275V-2PG	TT (1Ph+N)	D	230/-	275	40	20	≤1,3 (LN) ≤1,5 (N-PE)		C23	C27
83020117	STPT2-40K275V-2PGM	TT (1Ph+N)	D	230/-	275	40	20	≤1,3 (LN) ≤1,5 (N-PE)	√	C23	C27
83020118	STPT2-40K320V-2PG	TT (1Ph+N)	D	277/-	320	40	20	≤1,4 (LN) ≤1,5 (N-PE)		C24	C27
83020119	STPT2-40K320V-2PGM	TT (1Ph+N)	D	277/-	320	40	20	≤1,4 (LN) ≤1,5 (N-PE)	√	C24	C27
83020120	STPT2-40K150V-2P	TNS (1Ph+N)	F	120/-	150	40	20	≤0,9		C22	
83020121	STPT2-40K150V-2PM	TNS (1Ph+N)	F	120/-	150	40	20	≤0,9	√	C22	
83020122	STPT2-40K275V-2P	TNS (1Ph+N)	F	230/-	275	40	20	≤1,3		C23	
83020123	STPT2-40K275V-2PM	TNS (1Ph+N)	F	230/-	275	40	20	≤1,3	√	C23	
83020124	STPT2-40K320V-2P	TNS (1Ph+N)	F	277/-	320	40	20	≤1,4		C24	
83020125	STPT2-40K320V-2PM	TNS (1Ph+N)	F	277/-	320	40	20	≤1,4	√	C24	
83020126	STPT2-40K440V-2P	IT (1Ph+N); TNS (1Ph+N)	C	230/-; 400/-	440	40	20	≤2		C25	
83020127	STPT2-40K440V-2PM	IT (1Ph+N); TNS (1Ph+N)	C	230/-; 400/-	440	40	20	≤2	√	C25	

ELV

ELV Extra Low Voltage, also for use in DC Photovoltaic self-consumption / off-grid applications.

Electrical diagrams

A (1P)

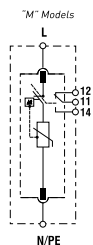

B (N)

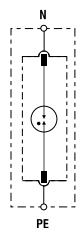

C 2+0 (2P)

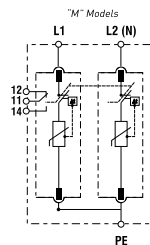

D 1+1 (2PG)

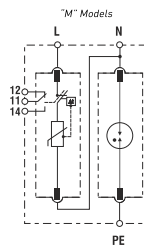

F 2+0 (2P)

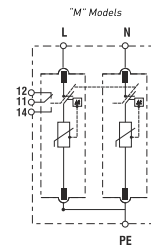

Surge-Trap® Type 2 SPDs STP T2 40



ep.mersen.com

Dimensions

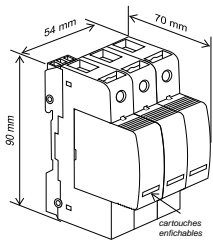

Electrical diagrams

H 3+0 (3P)

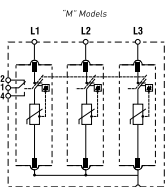

I 3+0 (3P)

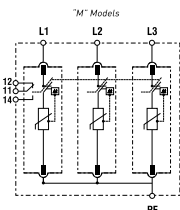

Dimensions

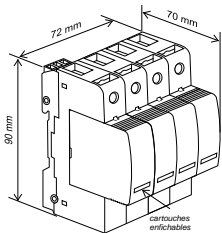

Electrical diagrams

J 3+1 (4P)

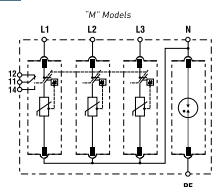

L 4+0 (4P)

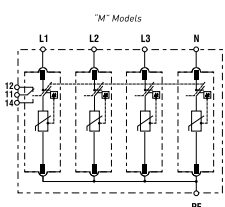

3 poles

REF. NUMBER	CAT. NUMBER	Network								Cartridge Id.	
		SYSTEM TYPE	ELECTRICAL DIAGRAM	UN [VAC]	UC [V]		IN (8/20) [KA]	UP@IN (8/20) [KV]	REMOTE (M)	L	N
83020132	STPT2-40K150V-3P	TNC (3Ph)	H	-/208	150	40	20	≤0,9		C22	-
83020133	STPT2-40K150V-3PM	TNC (3Ph)	H	-/208	150	40	20	≤0,9	√	C22	-
83020134	STPT2-40K275V-3P	TNC (3Ph)	H	-/400	275	40	20	≤1,3		C23	-
83020135	STPT2-40K275V-3PM	TNC (3Ph)	H	-/400	275	40	20	≤1,3	√	C23	-
83020136	STPT2-40K320V-3P	TNC (3Ph)	H	-/480	320	40	20	≤1,4		C24	-
83020137	STPT2-40K320V-3PM	TNC (3Ph)	H	-/480	320	40	20	≤1,4	√	C24	-
83020142	STPT2-40K440V-3P	IT (3Ph); TNC (3Ph)	I	-/400; -/690	440	40	20	≤2		C25	-
83020143	STPT2-40K440V-3PM	IT (3Ph); TNC (3Ph)	I	-/400; -/690	440	40	20	≤2	√	C25	-
83020102	STPT2-30K750V-3P	TNC (3Ph)	H	-/690; -/1000	750	30	15	≤3		C26	-
83020103	STPT2-30K750V-3PM	TNC (3Ph)	H	-/690; -/1000	750	30	15	≤3	√	C26	-

4 poles

REF. NUMBER	CAT. NUMBER	Network								Cartridge Id.	
		SYSTEM TYPE	ELECTRICAL DIAGRAM	UN [VAC]	UC [V]	IMAX (8/20) [KA]	IN (8/20) [KA]	UP@IN (8/20) [KV]	REMOTE (M)	L	N
83020144	STPT2-40K150V-4PG	TT (3Ph+N)	J	120/208	150	40	20	≤0,9 (LN) ≤1,5 (N-PE)		C22	C27
83020145	STPT2-40K150V-4PGM	TT (3Ph+N)	J	120/208	150	40	20	≤0,9 (LN) ≤1,5 (N-PE)	√	C22	C27
83020146	STPT2-40K275V-4PG	TT (3Ph+N)	J	230/400	275	40	20	≤1,3 (LN) ≤1,5 (N-PE)		C23	C27
83020147	STPT2-40K275V-4PGM	TT (3Ph+N)	J	230/400	275	40	20	≤1,3 (LN) ≤1,5 (N-PE)	√	C23	C27
83020148	STPT2-40K320V-4PG	TT (3Ph+N)	J	277/480	320	40	20	≤1,4 (LN) ≤1,5 (N-PE)		C24	C27
83020149	STPT2-40K320V-4PGM	TT (3Ph+N)	J	277/480	320	40	20	≤1,4 (LN) ≤1,5 (N-PE)	√	C24	C27
83020150	STPT2-40K150V-4P	TNS (3Ph+N)	L	120/208	150	40	20	≤0,9		C22	
83020151	STPT2-40K150V-4PM	TNS (3Ph+N)	L	120/208	150	40	20	≤0,9	√	C22	
83020152	STPT2-40K275V-4P	TNS (3Ph+N)	L	230/400	275	40	20	≤1,3		C23	
83020153	STPT2-40K275V-4PM	TNS (3Ph+N)	L	230/400	275	40	20	≤1,3	√	C23	
83020154	STPT2-40K320V-4P	TNS (3Ph+N)	L	277/480	320	40	20	≤1,4		C24	
83020155	STPT2-40K320V-4PM	TNS (3Ph+N)	L	277/480	320	40	20	≤1,4	√	C24	
83020156	STPT2-40K440V-4P	IT (3Ph+N); TNS (3Ph+N)	L	230/400; 400/690	440	40	20	≤2		C25	
83020157	STPT2-40K440V-4PM	IT (3Ph+N); TNS (3Ph+N)	L	230/400; 400/690	440	40	20	≤2	√	C25	

Replacement cartridges

REF. NUMBER	CAT. NUMBER	NETWORK	UN [VAC]	UC [V]	IMAX(8/20) [KA]	IN(8/20) [KA]	UP@IN(8/20) [KV]	ID. CARTOUCHE
83020008	SP2-40K60V	L-N (1Ph)	48	60	40	20	≤0,7	C20
83020009	SP2-40K75V	L-N (1Ph)	60	75	40	20	≤0,8	C21
83020001	SP2-40K150V	L-N (1Ph)	120	150	40	20	≤0,9	C22
83020002	SP2-40K275V	L-N (1Ph)	230	275	40	20	≤1,3	C23
83020003	SP2-40K320V	L-N (1Ph)	277	320	40	20	≤1,4	C24
83020004	SP2-40K440V	L-N (1Ph)	400	440	40	20	≤2	C25
83020007	SP2-30K750V	L-N (1Ph)	690	750	30	15	≤3	C26
83020000	SP2-40K-N	N-PE (N)	Neutral	265	40	20	≤1,5	C27

Surge-Trap® Type 2 Photovoltaic SPDs STP T2 40 PV



ep.mersen.com



No back-up fuse required



Approvals/Standards

- EN-50539-11
- UTE C 61740-51
- UL 1449 3rd Ed recognized, File No. E468946

Dimensions

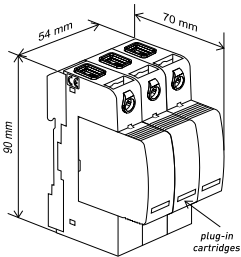

Electrical diagram

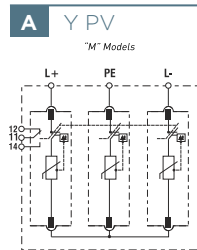

Replacement cartridges

REF. NUMBER	CAT. NUMBER	NETWORK	UCPV [VDC]	IMAX (8/20) [KA]	IN(8/20) @UP [KA]	UP@IN (8/20) [KV]	ID. CARTOUCHE
83020005	SP2-40K600V-PV	PV	330	40	20	≤1.3	C40
83020006	SP2-40K1000V-PV	PV	530	40	20	≤2	C41
83020010	SP2-40K1500V-PV	PV	750	40	10	≤2,5	C42

Microswitch diagram

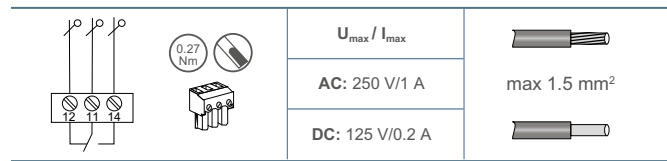

Surge-Trap® type 2+3 STP T23 20



1 pole

REF. NUMBER	CAT. NUMBER	Network										Cartridge Id.	
		SYSTEM TYPE	ELECTRICAL DIAGRAM	UN VAC]	UC [V]	IMAX (8/20) [KA]	IN (8/20) [KA]	UOC [KV]	UP@IN (8/20) [KV]	REMOTE (M)	L	N	
83230100	STPT23-20K150V-1P	L-N (1Ph)	A	120	150	20	10	10	≤0,8		C60	-	
83230101	STPT23-20K150V-1PM	L-N (1Ph)	A	120	150	20	10	10	≤0,8	√	C60	-	
83230102	STPT23-20K320V-1P	L-N (1Ph)	A	230 ; 277	320	20	10	10	≤1,4		C62	-	
83230103	STPT23-20K320V-1PM	L-N (1Ph)	A	230 ; 277	320	20	10	10	≤1,4	√	C62	-	
83230104	STPT23-20K440V-1P	L-N (1Ph)	A	400	440	20	10	10	≤2		C63	-	
83230105	STPT23-20K440V-1PM	L-N (1Ph)	A	400	440	20	10	10	≤2	√	C63	-	
83230106	STPT23-20K-N	N-PE (N)	B	Neutral	255	20	10	10	≤1,5		-	C64	

Approvals/Standards

- EN/CEI 61643-11
- CE

Dimensions

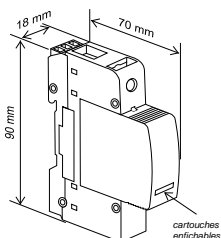

Electrical diagrams

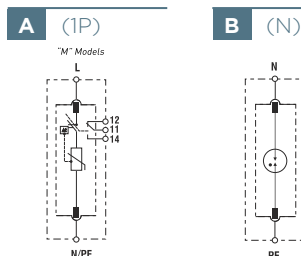

Microswitch diagram

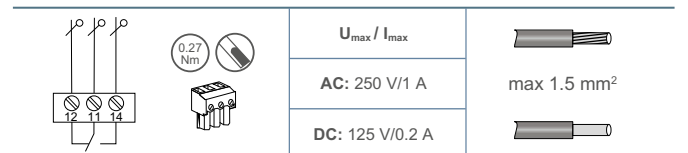

Surge-Trap® Type 2+3 SPDs STP T23 20



ep.mersen.com

Dimensions

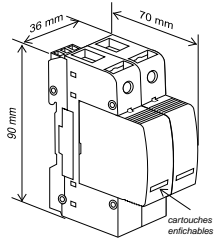

2 poles

REF. NUMBER	CAT. NUMBER	Network								Cartridge Id.		
		SYSTEM TYPE	ELECTRICAL DIAGRAM	UN [VAC]	UC [V]	IMAX (8/20) [KA]	IN (8/20) [KA]	UOC [KV]	UP@IN (8/20) [KV]	REMOTE (M)	L	N
83230108	STPT23-20K150V-2PG	TT (1Ph+N)	D	120/-	150	20	10	10	≤0,8 (L-N) ≤1,5 (N-PE)		C60	C64
83230109	STPT23-20K150V-2PGM	TT (1Ph+N)	D	120/-	150	20	10	10	≤0,8 (L-N) ≤1,5 (N-PE)	√	C60	C64
83230112	STPT23-20K320V-2PG	TT (1Ph+N)	D	230/-; 277/-	320	20	10	10	≤1,4 (L-N) ≤1,5 (N-PE)		C62	C64
83230113	STPT23-20K320V-2PGM	TT (1Ph+N)	D	230/-; 277/-	320	20	10	10	≤1,4 (L-N) ≤1,5 (N-PE)	√	C62	C64
83230110	STPT23-20K275V-2PG-LF	TT (1Ph+N)	E	230/-	275	20	10	10	≤1,5 (L-N) ≤1,5 (N-PE)		C61	C64
83230111	STPT23-20K275V-2PG-LFM	TT (1Ph+N)	E	230/-	275	20	10	10	≤1,5 (L-N) ≤1,5 (N-PE)	√	C61	C64
83230114	STPT23-20K150V-2P	TNS (1Ph+N)	F	120/-	150	20	10	10	≤0,8		C60	
83230115	STPT23-20K150V-2PM	TNS (1Ph+N)	F	120/-	150	20	10	10	≤0,8	√	C60	
83230116	STPT23-20K320V-2P	TNS (1Ph+N)	F	230/-; 277/-	320	20	10	10	≤1,4		C62	
83230117	STPT23-20K320V-2PM	TNS (1Ph+N)	F	230/-; 277/-	320	20	10	10	≤1,4	√	C62	
83230134	STPT23-20K275V-2P-LF	TNS (1Ph+N)	G	230/-	275	20	10	10	≤1,5		C61	
83230135	STPT23-20K275V-2P-LFM	TNS (1Ph+N)	G	230/-	275	20	10	10	≤1,5	√	C61	

Dimensions

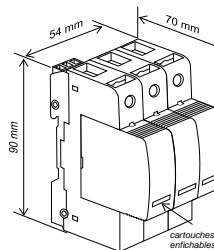

3 poles

REF. NUMBER	CAT. NUMBER	Network								Cartridge Id.		
		SYSTEM TYPE	ELECTRICAL DIAGRAM	UN [VAC]	UC [V]	IMAX (8/20) [KA]	IN (8/20) [KA]	UOC [KV]	UP@IN (8/20) [KV]	REMOTE (M)	L	N
83230118	STPT23-20K150V-3P	TNC (3Ph)	H	-/208	150	20	10	10	≤0,8		C60	-
83230119	STPT23-20K150V-3PM	TNC (3Ph)	H	-/208	150	20	10	10	≤0,8	√	C60	-
83230122	STPT23-20K320V-3P	TNC (3Ph)	H	-/400; -/480	320	20	10	10	≤1,4		C62	-
83230123	STPT23-20K320V-3PM	TNC (3Ph)	H	-/400; -/480	320	20	10	10	≤1,4	√	C62	-
83230120	STPT23-20K275V-3P-LF	TNC (3Ph)	N	-/400	275	20	10	10	≤1,5		C61	-
83230121	STPT23-20K275V-3P-LFM	TNC (3Ph)	N	-/400	275	20	10	10	≤1,5	√	C61	-

Electrical diagrams

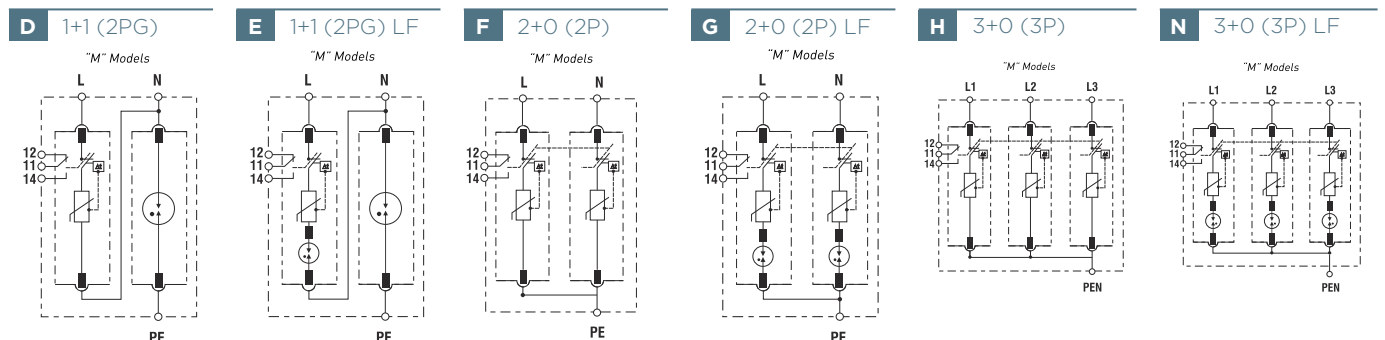

Surge-Trap® Type 2+3 SPDs STP T23 20



ep.mersen.com

Dimensions

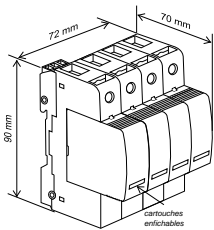

4 poles

REF. NUMBER	CAT. NUMBER	Network									Cartridge Id.		
		SYSTEM TYPE	ELECTRICAL DIAGRAM	UN [VAC]	UC [V]	IMAX (8/20) [KA]	IN (8/20) [KA]	UOC [KV]	UP@IN (8/20) [KV]	REMOTE (M)	L	N	
83230124	STPT23-20K150V-4PG	TT (3Ph+N)	J	120/208	150	20	10	10	10	≤0,8 [L-N] ≤1,5 [N-PE]		C60	C64
83230125	STPT23-20K150V-4PGM	TT (3Ph+N)	J	120/208	150	20	10	10	10	≤0,8 [L-N] ≤1,5 [N-PE]	√	C60	C64
83230128	STPT23-20K320V-4PG	TT (3Ph+N)	J	230/400; 277/480	320	20	10	10	10	≤1,4 [L-N] ≤1,5 [N-PE]		C62	C64
83230129	STPT23-20K320V-4PGM	TT (3Ph+N)	J	230/400; 277/480	320	20	10	10	10	≤1,4 [L-N] ≤1,5 [N-PE]	√	C62	C64
83230126	STPT23-20K275V-4PG-LF	TT (3Ph+N)	K	230/400	275	20	10	10	10	≤1,5 [L-N] ≤1,5 [N-PE]		C61	C64
83230127	STPT23-20K275V-4PG-LFM	TT (3Ph+N)	K	230/400	275	20	10	10	10	≤1,5 [L-N] ≤1,5 [N-PE]	√	C61	C64
83230130	STPT23-20K150V-4P	TNS (3Ph+N)	L	120/208	150	20	10	10	10	≤0,8		C60	
83230131	STPT23-20K150V-4PM	TNS (3Ph+N)	L	120/208	150	20	10	10	10	≤0,8	√	C60	
83230132	STPT23-20K320V-4P	TNS (3Ph+N)	L	230/400; 277/480	320	20	10	10	10	≤1,4		C62	
83230133	STPT23-20K320V-4PM	TNS (3Ph+N)	L	230/400; 277/480	320	20	10	10	10	≤1,4	√	C62	
83230136	STPT23-20K275V-4P-LF	TNS (3Ph+N)	M	230/400	275	20	10	10	10	≤1,5		C61	
83230137	STPT23-20K275V-4P-LFM	TNS (3Ph+N)	M	230/400	275	20	10	10	10	≤1,5	√	C61	

Electrical diagrams

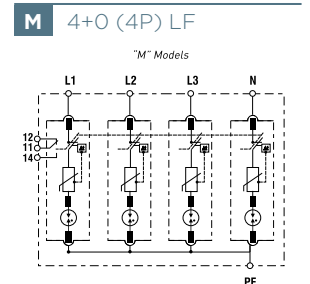
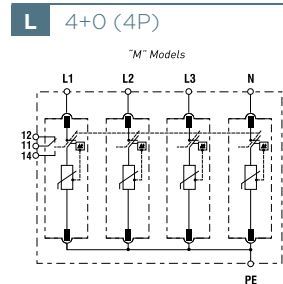
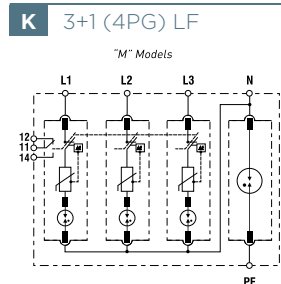
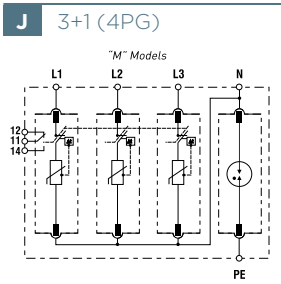

Replacement cartridges

REF. NUMBER	CAT. NUMBER	NETWORK	UN [VAC]	UC [V]	IMAX(8/20) [KA]	IN(8/20) [KA]	UOC [KV]	UP@IN(8/20) [KV]	CARTRIDGE ID.
83230001	SP23-20K150V	L-N (1Ph)	120	150	20	10	10	≤0,8	C60
83230003	SP23-20K275V-LF	L-N (1Ph)	230	275	20	10	10	≤1,3	C61
83230002	SP23-20K320V	L-N (1Ph)	230 ; 277	320	20	10	10	≤1,4	C62
83230004	SP23-20K440V	L-N (1Ph)	400	440	20	10	10	≤2	C63
83230000	SP23-20K-N	N-PE (N)	Neutral	255	20	10	10	≤1,5	C64

Surge-Trap® Type 2+3 SPDs STM T23 20 S Slim



ep.mersen.com



Approvals/ Standards

- EN/CEI 61643-11
- CE

2 poles

REF. NUMBER	CAT. NUMBER WITHOUT REMOTE MONIT.	CAT. NUMBER WITH REMOTE MONIT.	Network		UN [VAC]	UC [V]	IMAX (8/20) [KA]	IN (8/20) [KA]	UOC [KV]	UP@IN (8/20) [KV]
			SYSTEM TYPE	ELECTRICAL DIAGRAM						
83230500 83230501	STMT23-6K20V-SP-S	STMT23-6K20V-SP-SM	TT/TNS (1Ph+N)	A	12	20	6	3	6	≤0,22 (L1-L2) 0,7 (L1/L2-PE)
83230504 83230505	STMT23-6K30V-SP-S	STMT23-6K30V-SP-SM	TT/TNS (1Ph+N)	A	24	30	6	3	6	≤0,22 (L1-L2) 0,7 (L1/L2-PE)
83230506 83230507	STMT23-6K60V-SP-S	STMT23-6K60V-SP-SM	TT/TNS (1Ph+N)	A	48	60	6	3	6	≤0,33 (L1-L2) 0,7 (L1/L2-PE)
83230508 83230509	STMT23-6K75V-SP-S	STMT23-6K75V-SP-SM	TT/TNS (1Ph+N)	A	60	75	6	3	6	≤0,5 (L1-L2) 0,9 (L1/L2-PE)
83230502 83230503	STMT23-6K150V-SP-S	STMT23-6K150V-SP-SM	TT/TNS (1Ph+N)	A	120	150	6	3	6	≤0,7 (L1-L2) 0,9 (L1/L2-PE)
83230510 83230511	STMT23-20K275V-SP-S	STMT23-20K275V-SP-SM	TT/TNS (1Ph+N)	A	230	275	20	10	10	≤1,4 (L1-L2) 1,4 (L1/L2-PE)

Dimensions

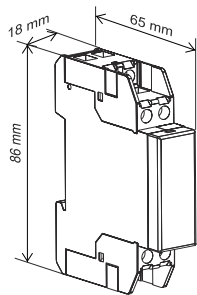

Electrical diagram

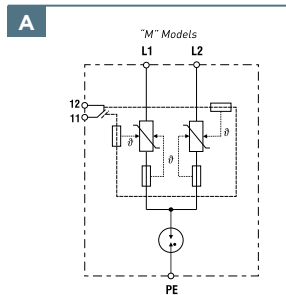

Microswitch diagram

	U _{max} / I _{max}
AC:	250 V/1 A
DC:	125 V/0.2 A

STE T23 20 EMI



2 poles

REF. NUMBER	CAT. NUMBER	Network		UN [VAC]	UC [V]	IMAX (8/20) [KA]	IN (8/20) [KA]	UOC [KV]	UP@IN [KV]	IL [A]	REMOTE (M)
		SYSTEM TYPE	ELECTRICAL DIAGRAM								
83230401	STET23-20K150V-SPM	TT/TNS (1Ph+N)	A	120	150	20	10	6	≤0.8	20	√
83230403	STET23-20K275V-SPM	TT/TNS (1Ph+N)	A	230	275	20	10	6	≤1.2	20	√

Approvals/ Standards

- EN/CEI 61643-11
- CE

Dimensions

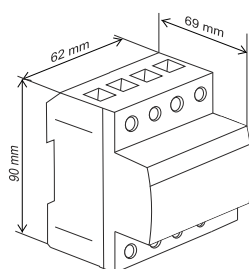

Electrical diagram

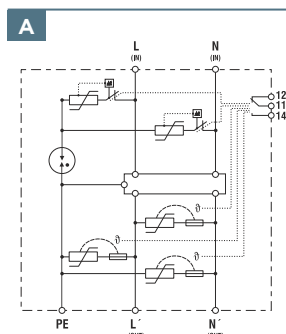

Microswitch diagram

	U _{max} / I _{max}
AC:	250 V/1 A
DC:	125 V/0.2 A

max 1.5 mm²

FSPDB FINGER-SAFE POWER DISTRIBUTION BLOCKS



ep.mersen.com



CAT. NUMBER		AMPERE RATING (A)	LINE			LOAD			SHORT CIRCUIT CURRENT RATING
ALUMINIUM CONNECTOR RATED FOR 90°C CU/AL WIRE	COPPER CONNECTOR RATED FOR 75°C CU WIRE ONLY		AWG	MM ²	OPENINGS	AWG/KCMIL	MM ²	OPENINGS PER POLE	
FSPDB1A	FSPDB1C	175	2/0-#14	70-2.5	1	2/0-#14	70-2.5	1	100kA*
FSPDB2A	FSPDB2C	175	2/0-#14	70-2.5	1	#2-#14	35-2.5	4	100kA*
FSPDB3A	FSPDB3C	310	350-#6 2/0-#14	185-16 70-2.5	1	#8-#14	8-2.5	8	100kA*
FSPDB4A	FSPDB4C	335	400-#6	185-16	1	400-#6	185-16	1	100kA*
FSPDB5A	FSPDB5C	840	600-#4	300-25	2	600-#4	300-25	2	100kA*

Dimensions

MULTIPLE WIRE RATINGS (SAME SIZE & TYPE WIRES ONLY)			
2/0 OPENINGS		#2 OPENINGS	
(2) #4 AWG	(2) #10 AWG	(2) #6 AWG	(2-4) #12 AWG
(2) #6 AWG	(2) #12 AWG	(2) #8 AWG	(2-4) #14 AWG
(2) #8 AWG	(2) #14 AWG	(2-4) #10 AWG	-

DIMENSION	FSPDB1A FSPDB1C FIGURE 1		FSPDB2A FSPDB2C FIGURE 1		FSPDB3A FSPDB3C FIGURE 2		FSPDB4A FSPDB4C FIGURE 1		FSPDB5A FSPDB5C FIGURE 2	
	MM	IN	MM	IN	MM	IN	MM	IN	MM	IN
A	25.4	1.00	28.4	1.12	46.9	1.85	39	1.54	72	2.84
B	43.3	1.70	57.8	2.28	64.3	2.53	108	4.25	91	3.58
C	49.5	1.95	56.0	2.21	64.3	2.53	80	3.15	80	3.15
D	45.1	1.78	51.6	2.03	59.8	2.36	75.5	2.97	-	-
E	39.4	1.55	39.4	1.55	51.5	2.03	50.1	1.97	50.1	1.97
F	72.6	2.86	87.7	3.45	100.8	3.97	145.5	5.73	145	5.71
G	59.6	2.35	74.6	2.94	82.4	3.24	120.6	4.75	127.5	5.02
H	5.3	0.21	5.1	0.20	6.5	0.26	7	0.28	3	0.12
I	-	-	-	-	31.5	1.24	-	-	52	2.04
J	5.3	0.21	6.4	0.25	6.5	0.26	6.5	0.26	6.5	0.26
K	10	0.40	11.7	0.46	8.9	0.35	16	0.63	8.5	0.34

Accessories

CAT. NUMBER	DESCRIPTION
FSPIN1	Accessory pin to form multiple pole block
FSCIM1	Circuit identification marker for 2/0 & #2 max. conductors (80 per card)
FSCIM2	Circuit identification marker for 350, 400 & 600 kcmil max. conductors (56 per card)
FSCAP1	FSCAP1 Cap plug for spare 2/0 openings
FSCAP2	FSCAP2 Cap plug for spare 350 kcmil openings
FSCAP3	FSCAP3 Cap plug for spare 600 kcmil opening
FSEA	FSEA Pair of end anchors

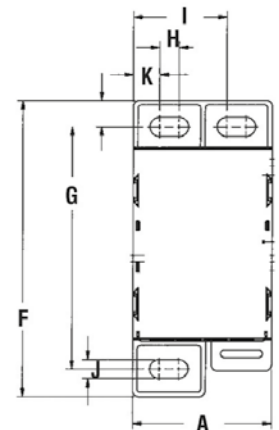
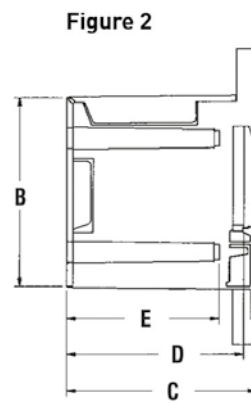
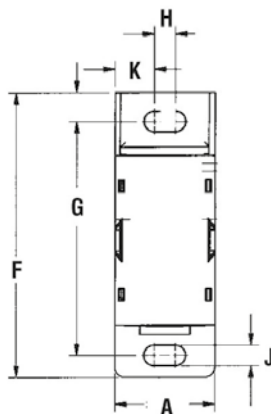
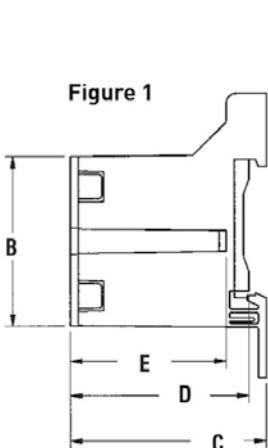

IEC SWITCH DISCONNECTORS

IEC Switch Disconnectors – Front Operated



M163



M163DM



M633



M633DM



M100U3 - M125E3

Switch Body

Handles and Shafts



AMPERE RATING (A)	16	25	40	63	80	100	125
CAT. NUMBER BASE	M163	M253	M403	M633	M803	M100U3	M125E3
DOOR-MOUNTED VERSION	M163DM	M253DM	M403DM	M633DM	M803DM	M100U3DM	

DIRECT FRONT OPERATION LOCKING HANDLE							
	HD40	HD40	HD40	HD125	HD125	HD125	HD125

EXTERNAL FRONT OPERATION							
Selector Style IP65, NEMA 1, 3R, 12	HSBX	HSBX	HSBX	HSBX	HSBX	HSBX	HSBX
Shaft Lengths: 85, 130, 180, 250 Ex. SA130	SA_	SA_	SA_	SA_	SA_	SA_	SA_
Door mounted version (no shaft required)	HSBPDM	HSBPDM	HSBPDM	HSBWDM	HSBWDM	HSBWDM	HSBWDM
Pistol Style IP65, NEMA 1, 3R, 12	HB45	HB45	HB45	HB45	HB45	HB45	HB45
Shaft Lengths: 210, 290 Ex. SPA210	SPA_	SPA_	SPA_	SPA_	SPA_	SPA_	SPA_

B=Black. Substitute 'R' for 'B' if a red handle is desired. Ex. HR65

Accessories

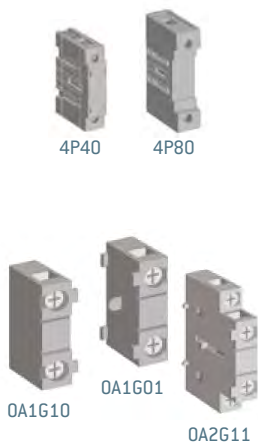

FOURTH POLES							
Limited to one additional pole per switch	4P40	4P40	4P40	4P80	4P80	4P125	4P125

NEUTRAL POLES							
Limited to one additional pole per switch	NP40	NP40	NP40	NP80	NP80	NP125	NP125

TERMINAL SHROUDS							
3-pole, 1 terminal shroud for 3 poles	TS40-3	TS40-3	TS40-3	TS63-3	TS63-3	TS125-3	TS125-3
1 to 4-poles, 1 terminal shroud per pole	TS40-1	TS40-1	TS40-1	TS63-1	TS63-1	TS125-1	TS125-1

AUXILIARY CONTACTS							
NC left or right side mounting	0A1G01	0A1G01	0A1G01	0A1G01	0A1G01	0A1G01	0A1G01
NO left or right side mounting	0A1G10	0A1G10	0A1G10	0A1G10	0A1G10	0A1G10	0A1G10
NO+NC (Mounting on either side)	0A2G11	0A2G11	0A2G11	0A2G11	0A2G11	0A2G11	0A2G11

IEC Front and Side Operated



ep.mersen.com



M200E30S



M630E03

Switch Body

Handles and Shafts



HD250



HB65

Accessories



4P40

4P80

4P125



4P250

TS250-1

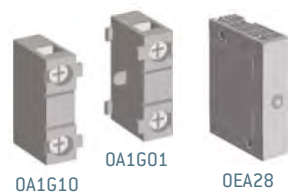

OA1G10

OA1G01

OEA28

AMPERE RATING (A)	200	250	315	400	630	800
CAT. NUMBER BASE	M200E	M250E	M315E	M400E	M630E	M800E
3 poles	03, 30S	03, 30S	03, 30S	03, 30S	03, 30S	03, 30S

DIRECT FRONT OPERATION LOCKING HANDLE

	HD250	HD250	HD400	HD400	HD800	HD800
--	-------	-------	-------	-------	-------	-------

EXTERNAL FRONT OPERATION

Pistol Style NEMA 1, 3R, 12	HB65/HB80	HB65/HB80	HB125	HB125	HB125	HB125
Pistol Type, right side operation	HB65S	HB65S	HB145S	HB145S	HB145S	HB145S
Shaft Lengths: 210, 290, 360, 430 Ex. SPA210 Shaft Lengths: 280, 325, 395 Ex. SFB325	SPA_	SPA_	SFB_	SFB_	SFB_	SFB_

B = Black. Substitute "R" for "B" if red handle is desired. Ex. HR80.

FOURTH POLES

	4P250	4P250	4P400	4P400	4P800	4P800
--	-------	-------	-------	-------	-------	-------

NEUTRAL POLES

	NP250	NP250	NP400	NP400	NP800	NP800
--	-------	-------	-------	-------	-------	-------

TERMINAL SHROUDS

Kit for 3 poles	TS250-13	TS250-13	TS400-13	TS400-13	TS800-13	TS800-13
Kit for 4 poles	TS250-14	TS250-14	TS400-14	TS400-14	TS800-14	TS800-14

Shorter terminal shrouds versions are also available if desired. Ex. TS250S-13 for switches up to 250A

AUXILIARY CONTACTS

Normally Open	OA1G10	OA1G10	OA1G10	OA1G10	OA1G10	OA1G10
Normally Closed	OA3G01	OA3G01	OA3G01	OA3G01	OA3G01	OA3G01
Module for SF aux. contacts	OEA28	OEA28	OEA28	OEA28	OEA28	OEA28

IEC SWITCH DISCONNECTORS

IEC Non-Fused switches, front-operated

CAT. NUMBER	DESCRIPTION	REF. NUMBER
M163	IEC UL508 Switch 16A 3p	A1043188
M253	IEC UL508 Switch 25A 3p	B1043189
M403	IEC UL508 Switch 40A 3p	C1043190
M633	IEC UL508 Switch 63A 3p	D1043191
M803	IEC UL508 Switch 80A 3p	E1043192
M100U3	IEC UL98 Switch 100A 3p	F1043193
M125E3	IEC Switch 125A 3p	G1043194
M163DM	IEC UL508 Switch 16A 3p DM	E1043169
M253DM	IEC UL508 Switch 25A 3p DM	F1043170
M403DM	IEC UL508 Switch 40A 3p DM	K1043174
M633DM	IEC UL508 Switch 63A 3p DM	M1043176
M803DM	IEC UL508 Switch 80A 3p DM	N1043177
M100U3DM	IEC UL98 Switch 100A 3p DM	P1043178
M200E03	IEC Switch 200A 3p 0+3 pos.	H1043195
M250E03	IEC Switch 250A 3p 0+3 pos.	K1043197
M315E03	IEC Switch 315A 3p 0+3 pos.	M1043199
M400E03	IEC Switch 400A 3p 0+3 pos.	P1043201
M630E03	IEC Switch 630A 3p 0+3 pos.	R1043203
M800E03	IEC Switch 800A 3p 0+3 pos.	T1043205

IEC Non-Fused switches, side-operated

CAT. NUMBER	DESCRIPTION	REF. NUMBER
M200E30S	IEC Switch 200A 3p R side op.	J1043196
M250E30S	IEC Switch 250A 3p R side op.	L1043198
M315E30S	IEC Switch 315A 3p R side op.	N1043200
M400E30S	IEC Switch 400A 3p R side op.	Q1043202
M630E30S	IEC Switch 630A 3p R side op.	S1043204
M800E30S	IEC Switch 800A 3p R side op.	V1043206

Handles

CAT. NUMBER	DESCRIPTION	REF. NUMBER
HD40	Handle direct Switch 40A	L1043405
HSBX	Handle selector black	M1043406
HSRX	Handle selector red	N1043407
HB45	Handle black 45mm IP65 NEMA 3R	L1043911
HR45	Handle red 45mm IP65 NEMA 3R	Q1043915
HD125	Handle direct Switch 125A	K1043404
HD250	Handle direct Switch 250A	W1043391
HD400	Handle direct Switch 400A	X1043392
HD800	Handle direct Switch 800A	Y1043393
HB65	Handle black 65mm IP65 NEMA 3R	W1043368
HB65S	Handle black 65mm Right Side	A1044361
HB80	Handle black 80mm IP65 NEMA 3R	Y1043370
HB95	Handle black 95mm IP65 NEMA 3R	N1043913
HB125	Handle black 125mm IP65 NEMA 3R	A1043372
HB145	Handle black 145mm IP65 NEMA 3R	C1043374
HB145S	Handle black 145mm Right Side	B1044362
HB274	Handle black 274mm IP65 NEMA 3R	D1043398
HB330	Handle black 330mm IP65 NEMA 3R	E1043399
HR65	Handle red 65mm IP65 NEMA 3R	G1043378
HR80	Handle red 80mm IP65 NEMA 3R	F1043400
HR95	Handle red 95mm IP65 NEMA 3R	S1043917
HR125	Handle red 125mm IP65 NEMA 3R	K1043381
HR145	Handle red 145mm IP65 NEMA 3R	M1043383
HR274	Handle red 274mm IP65 NEMA 3R	G1043401
HR330	Handle red 330mm IP65 NEMA 3R	H1043402
HSBPDM	Handle Select black snap door	X1044358
HSBWDM	Handle Select black screw door	Y1044359
HSRPDM	Handle Select red snap door	E1047792
HSRWDM	Handle Select red screw door	D1047791

Shafts

CAT. NUMBER	DESCRIPTION	REF. NUMBER
SA85	Shaft selector handle 6x6x85mm	J1043426
SA105	Shaft select. handle 6x6x105mm	K1043427
SA120	Shaft select. handle 6x6x120mm	L1043428
SA130	Shaft select. handle 6x6x130mm	M1043429
SA180	Shaft select. handle 6x6x180mm	N1043430
SA250	Shaft pistol handle 6x6x250mm	R1043433
SPA130	Shaft pistol handle 6x6x130mm	V1043919
SPA210	Shaft pistol handle 6x6x210mm	P1043431
SPA290	Shaft pistol handle 6x6x290mm	Q1043432
SPA360	Shaft pistol handle 6x6x360mm	W1043920
SPA430	Shaft pistol handle 6x6x430mm	X1043921
SFB185	Shaft SwitchFuse 12x12x185mm	F1048897
SFB280	Shaft SwitchFuse 12x12x280mm	F1043423
SFB325	Shaft SwitchFuse 12x12x325mm	G1043424
SFB395	Shaft SwitchFuse 12x12x395mm	H1043425

Terminal Shrouds

CAT. NUMBER	DESCRIPTION	REF. NUMBER
TS40-1	Term.shrd 40A switch 1p S	B1043442
TS40-3	Term.shrd 40A switch 3p L	C1043443
TS63-1	Term.shrd 63A switch 1p S	D1043444
TS63-3	Term.shrd 63A switch 3p L	E1043445
TS125-1	Term.shrd 125A switch 1p S	F1043446
TS125-3	Term.shrd 25A switch 3p L	G1043447
TS250-13	Term.shrd 250A switch 1p L /3	P1043454
TS250-14	Term.shrd 250A switch 1p L /4	A1043464
TS400-13	Term.shrd 400A switch 1p L /3	Q1043455
TS400-14	Term.shrd 400A switch 1p L /4	B1043465
TS800-13	Term.shrd 800A switch 1p L /3	R1043456
TS800-14	Term.shrd 800A switch 1p L /4	C1043466
TS250S-13	KIT 3 Term.shrd M250 1p S	P1048905
TS250S-14	KIT 4 Term.shrd M250 1p S	Q1048906
TS400S-13	KIT 3 Term.shrd M400 1p S	R1048907
TS400S-14	KIT 4 Term.shrd M400 1p S	S1048908
TS800S-13	KIT 3 Term.shrd M800 1p S	T1048909
TS800S-14	KIT 4 Term.shrd M800 1p S	V1048910



ep.mersen.com

Other Accessories

CAT. NUMBER	DESCRIPTION	REF. NUMBER
0A1G01	Auxiliary Contact NC Right	N1043476
0A1G10	Auxiliary Contact NO left	P1043477
0A2G11	Aux. Contact NO+NC Switch 125A	Q1043478
4P60	Fourth pole for M60 NF switches	T1043481
4P80	Fourth pole for M80 NF switches	V1043482
4P125	Fourth pole for M125 switches	W1043483
NP40	Neutral pole for M40 NF switches	X1043484
NP80	Neutral pole for M80 NF switches	Y1043485
NP125	Neutral pole for M125 switches	Z1043486
0A1G01	Auxiliary Contact NO Right	N1043476
0A1G10	Auxiliary Contact NC left	P1043477
0A2G11	Aux. Contact NO+NC Switch 125A	Q1043478
0A3G01	Aux.Contact NC Switch 160-2500A	R1043479
0A4B1C	Aux.Contact 1+1 SF 40A	K1043473
OSZ4	Mounting plate 0A1G10/0A3G01	L1043474
0EA28	Module for SF aux. contacts	M1043475
4P125	Fourth pole for M125 NF switches	W1043483
4P250	Neutral pole for M250 NF switches	A1043487
4P400	Neutral pole for M400 NF switches	B1043488
4P800	Neutral pole for M800 NF switches	C1043489

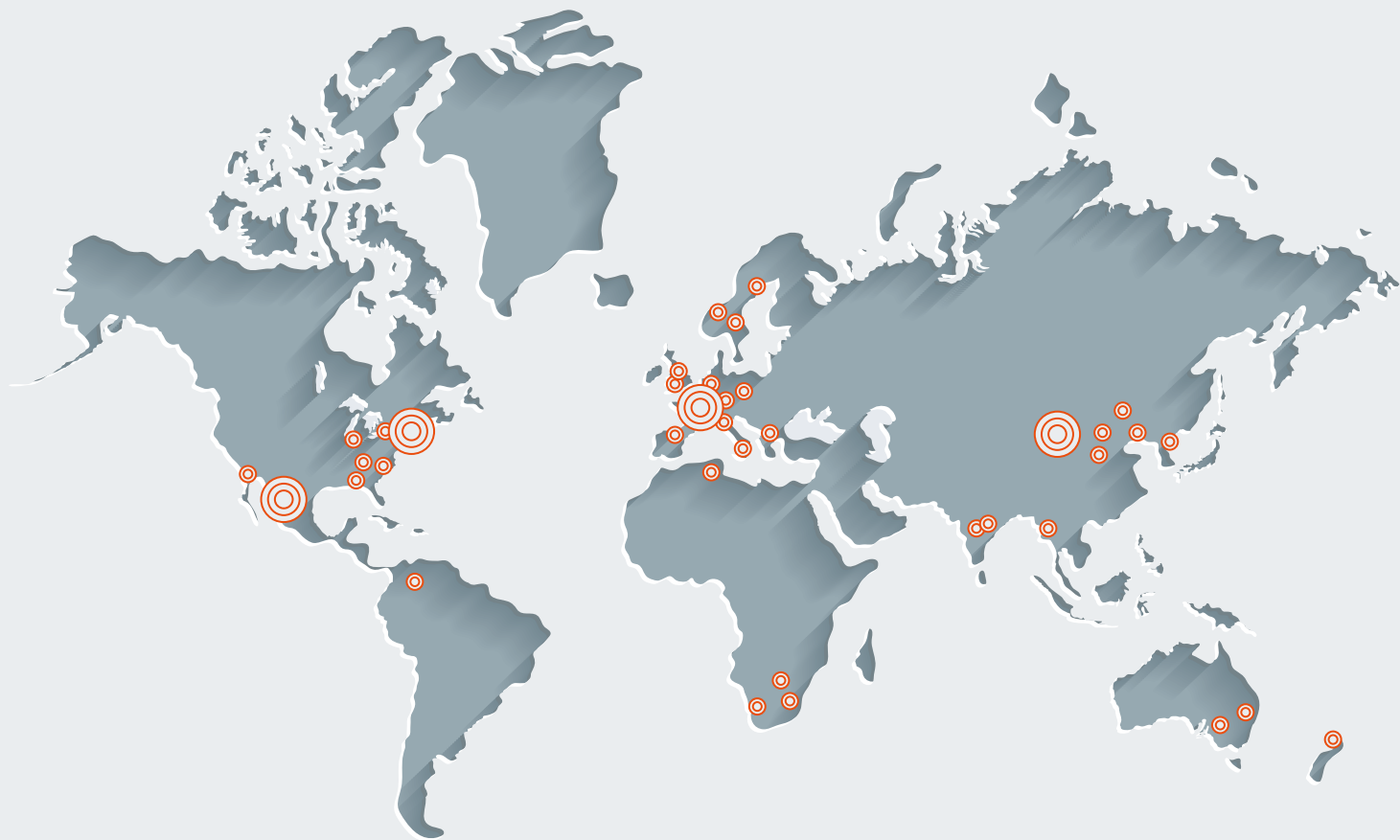

MERSEN IS A GLOBAL EXPERT
IN ELECTRICAL SPECIALTIES
& GRAPHITE-BASED MATERIALS

EUROPE

FRANCE
Mersen France SB S.A.S.
15 rue Jacques de Vaucanson
F-69720 Saint-Bonnet-de-Mure
+33 4 72 22 66 11
info.sbm@mersen.com

ALLEMAGNE
Mersen Deutschland Eggolsheim GmbH
In der Büg 12
D-91330 Eggolsheim
+49 9191 7338 0
vertrieb.eggolsheim@mersen.com



EP.MERSEN.COM